

Wuerth Industrial Services Malaysia

CUTTERS, KNIVES, AND ACCESSORIES



Cutters and trapezoidal blade knives	4-7
Safety knives	8-9
Carpet knives	10-11
Matching blades and knife pouches	12-15
Universal knives	16-17
Insulation knives	18-19
Scrapers	20-22



KNIVES AND CUTTERS – STRONG, FLEXIBLE TOOLS!



Knives are indispensable tools for everyday work in workshops, on construction sites, and in the home. Whether opening boxes, plastic packaging, or packaging straps. The potential uses are infinite.

THE NUMBER OF ACCIDENTS AT WORK INVOLVING KNIVES IS UNVARYINGLY HIGH.

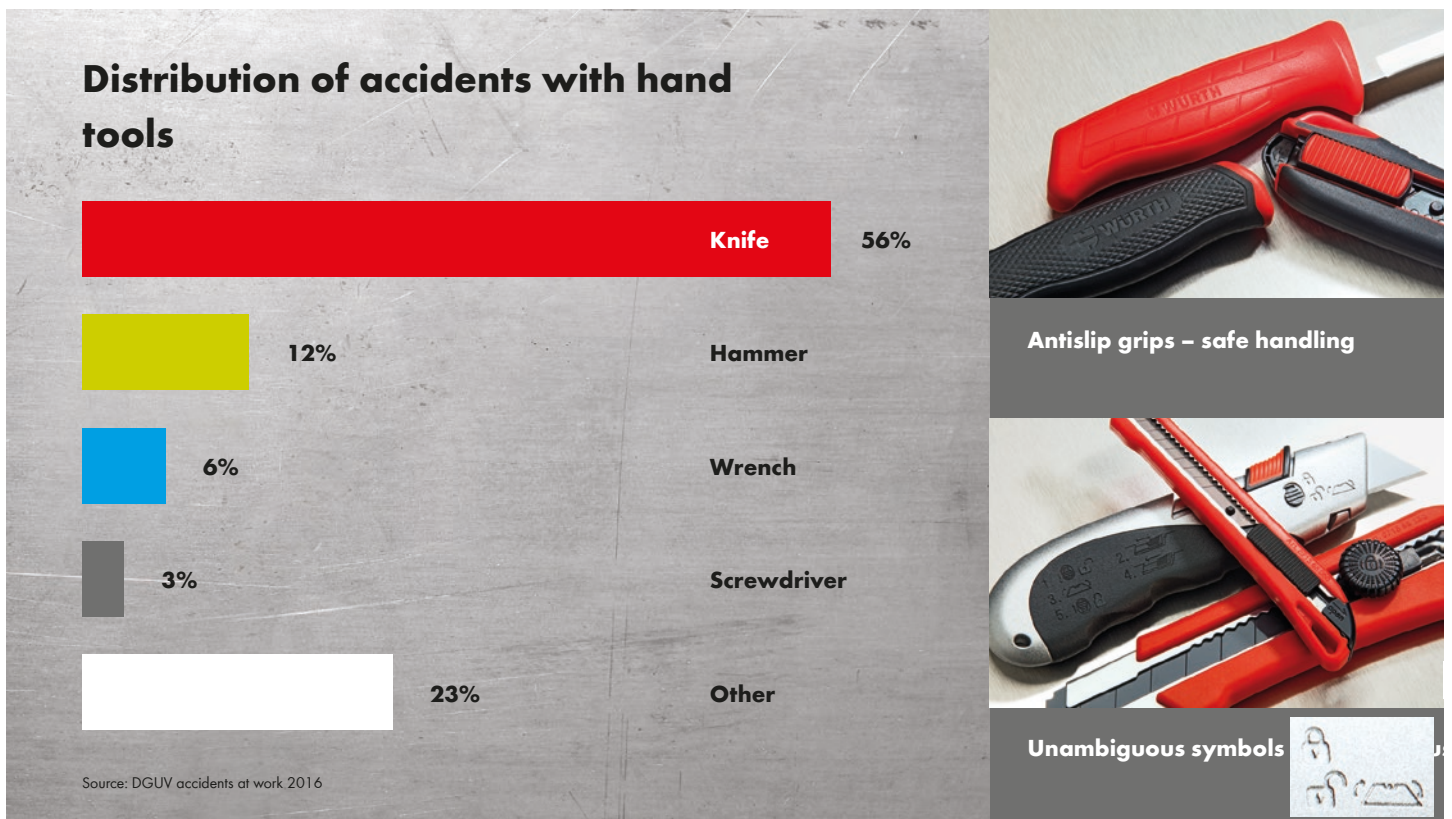

Under § 193(1) SGB VII (German social laws), an employer must report every accident on his premises involving injury to an employee that renders him unable to work for longer than three days. On the list of notifiable accidents, hand tools are right at the top. Of the hand tools causing injury, knives are the most frequent cause of injuries to employees (56%). Injuries of this kind are extremely painful not only to the employee. An accident of this kind also entails inability to work, delays in the course of work, and additional hours of the colleagues.

All Würth knives are equipped with antislip grips for a better hold. So that you can find the right knife for each application, the following pages present example uses for each tool.

CUTTERS AND TRAPEZOIDAL BLADE KNIVES



1C CUTTER

Standard cutter, simple and good.

- Handle of impact-resistant plastic
- Precise blade guide of stainless steel
- Ergonomic handle shape
- Delivery includes extremely sharp blades



1C cutter 9 mm

- Automatic blade locking
Max pressure load 5 kg
- Length: 140 mm
- Incl blade magazine for 2 blades
- Delivery includes 3 extremely sharp break-off blades

Art. no. 0715 66 060

PU/Qty 1

Compatible blades:

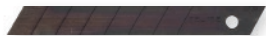

9 mm break-off blade, extremely sharp

Art. no. 0715 66 073



9 mm break-off blade, bare

Art. no. 0715 66 07

Example uses:

For opening envelopes and packages



1C cutter 18 mm

- Automatic blade locking
Max pressure load 12 kg
- Length: 155 mm
- Incl blade magazine for 2 blades
- Delivery includes 3 extremely sharp break-off blades

Art. no. 0715 66 210

PU/Qty 1

Compatible blades:



18 mm break-off blade, extremely sharp

Art. no. 0715 66 053



18 mm break-off blade, bare

Art. no. 0715 66 05

Example uses:

For trimming cover fleece and roof protection film



1C cutter 25 mm

- Clamping screw for zero backlash blade locking
- Length: 185 mm
- Without blade magazine
- Delivery includes 1 extremely sharp break-off blade

Art. no. 0715 66 350

PU/Qty 1

Compatible blades:



25 mm break-off blade, extremely sharp

Art. no. 0715 66 093



25 mm break-off blade, bare

Art. no. 0715 66 351

Example uses:

For cutting thick cardboard and foams



2C CUTTER

Premium cutter, high quality and robust.

- Antislip and ergonomic 2C handle and slide button for fatigue-free working
- Convenient, automatic blade locking
- Simple single-handed use
- Very stable and precise blade guide
- Delivery includes extremely sharp blades



2C cutter 9 mm

- Automatic blade locking
Max pressure load 5 kg
- Length: 160 mm
- Without blade magazine
- Delivery includes 1 extremely sharp break-off blade

Art. no. 0715 66 274 PU/Qty 1

Compatible blades:

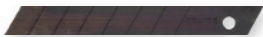

9 mm break-off blade, extremely sharp
Art. no. 0715 66 073



9 mm break-off blade, bare
Art. no. 0715 66 07

Example uses:

For opening packaging and packages



2C cutter 18 mm

- Automatic blade locking
Max pressure load 12 kg
- Length: 170 mm
- Incl blade magazine for 2 blades
- Delivery includes 3 extremely sharp break-off blades

Art. no. 0715 66 275 PU/Qty 1

Compatible blades:

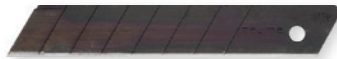

18 mm break-off blade, extremely sharp
Art. no. 0715 66 053



18 mm break-off blade, bare
Art. no. 0715 66 05



18 mm stainless steel cutting blade
Art. no. 0715 66 085

Example uses:

For cutting insulation



2C cutter 25 mm

- Automatic blade locking
Max pressure load 20 kg
- Length: 195 mm
- Without blade magazine
- Delivery includes 1 extremely sharp break-off blade

Art. no. 0715 66 276 PU/Qty 1

Compatible blades:



25 mm break-off blade, extremely sharp
Art. no. 0715 66 093



25 mm break-off blade, bare
Art. no. 0715 66 351

Example uses:

For cutting and shredding thick cardboard



3C CUTTER

Solid 3C cutter with additional clamping screw.

- Solid handle of aluminum and 2C design for safe handling
- Clamping screw secures the blade free of backlash
- Precise, non-rusting metal blade guide
- 2C slide button for convenient single-handed use
- Delivery includes extremely sharp blade.



3C cutter 18 mm

- Clamping screw for highly rigid automatic blade locking
- Length: 170 mm
- Delivery includes 1 extremely sharp break-off blade

Art. no. 0715 66 277 PU/Qty 1

Compatible blades:



18 mm break-off blade, extremely sharp
Art. no. 0715 66 053



18 mm break-off blade, bare
Art. no. 0715 66 05

Example uses:

For all cutting work, specifically for materials tending to clog, e.g. foams, polystyrene, gypsum plasterboard, insulation, etc.



TRAPEZOIDAL BLADE KNIVES

Universal knife with bit holder and cable stripper.

- Ergonomic handle of aluminum
- With secure belt clip



Trapezoidal blade knives

- Fast and simple blade advance and reliable locking
- With magnetic 1/4" bit holder
- Length: 125 mm

Art. no. 0715 66 515

PU/Qty 1

Compatible blades:



Trapezoidal blade
Art. no. 0715 66 02



Bi-metal trapezoidal blade
Art. no. 0715 66 021

Example uses:

For tightening and loosening screws for professional, amateur, and recreational purposes. For stripping conductors and cutting cords to length.

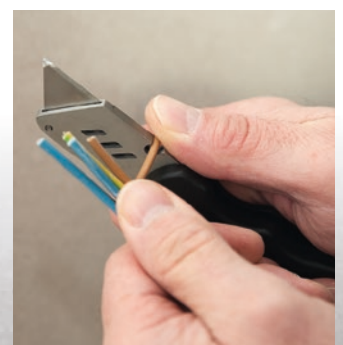

SAFETY KNIFES



SAFETY KNIVES

Integrated safety concept for minimized accident risk.

- Ergonomic and solid handles for safe working
- Delivery includes trapezoidal blades



Safety knife Safety class 1

S1 Automatic blade retraction when thumb removed from slide (depending on user)

- Toolless blade changes, including blade magazine for 5 replacement blades
- Delivery includes 1 bi-metal trapezoidal blade
- Length: 170 mm

Art. no. 0715 66 013 PU/Qty 1

Compatible blades:



Trapezoidal blade
Art. no. 0715 66 02



Bi-metal trapezoidal blade
Art. no. 0715 66 021

Example uses:

For cutting packaging straps and removing packaging film



Safety knife Safety class 2

S2 Fully automatic blade retraction after cutting even when slide pressed (depending on user)

- Toolless blade changes, no blade magazine
- Delivery includes 1 trapezoidal blade
- Length: 160 mm

Art. no. 0715 66 017 PU/Qty 1

Compatible blades:



Trapezoidal blade
Art. no. 0715 66 02



Bi-metal trapezoidal blade
Art. no. 0715 66 021

Example uses:

For opening packaging and shredding cardboard



CARPET KNIFE



CARPET KNIFE

With stepped blade locking.

- Ergonomic and solid handles for safe working
- Delivery includes robust trapezoidal blades



Carpet knife

- Blade locking at 4 places; blade can be retracted completely
- Screw lock for blade changes, without blade magazine
- Delivery includes 1 trapezoidal blade
- Length: 160 mm

Art. no. 0715 66 01 PU/Qty 1



2C carpet knife

- Blade locking at 4 places; blade can be retracted completely
- Toolless blade changes, including blade magazine for 5 replacement blades
- Delivery includes 1 bi-metal trapezoidal blade
- Length: 170 mm

Art. no. 0715 66 015 PU/Qty 1



Aluminum carpet knife

- Secure blade locking, blade isolated in case
- Toolless blade changes, including blade magazine for 10 replacement blades
- Delivery includes 2 trapezoidal blades, Art. 0714 662 11 with 180 mm long ground corrugated blade
- Length: 170 mm

Art. no. 0714 662 11 ① / **0714 662 12** ②
PU/Qty 1

Compatible blades for all four carpet knives:



Trapezoidal blade

Art. no. 0715 66 02



Hook blade

Art. no. 0715 66 03



Bi-metal trapezoidal blade

Art. no. 0715 66 021



Concave blade

Art. no. 0715 665 23

Compatible blades:

For long knife, art. no. 0714 662 11



Ground smooth blade, 180 mm long

Art. no. 0715 665 41



Ground smooth blade, 180 mm long

Art. no. 0715 665 42

Example uses:

For cutting floor coverings



Example uses:

For trimming carpets and edge strips



Example uses:

For cutting insulation



BLADE / KNIFE POUCHES



BREAK-OFF BLADES IN DISPENSER

Blade 9 mm

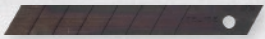

Total length: 85 mm

Art. no. 0715 66 073
PU/Qty 10 in slide dispenser

Blade 18 mm

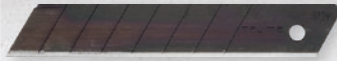

Total length: 110 mm

Art. no. 0715 66 053
PU/Qty 10 in slide dispenser

Blade 25 mm



Total length: 140 mm

Art. no. 0715 66 093
PU/Qty 10 in slide dispenser



Extreme sharp ground blade for precision cuts even of fine strips.
Acute cutting angle and top-quality steel make the blade extremely sharp.



Total length: 85 mm

Art. no. 0715 66 07
PU/Qty 10 in slide dispenser



Total length: 110 mm

Art. no. 0715 66 05
PU/Qty 10 in slide dispenser



Total length: 140 mm

Art. no. 0715 66 351
PU/Qty 10 in dispenser box



Best compromise between long service life and sharp cutting edge.
Ice hardened cutting edge for high cutting quality.

BREAK-OFF BLADE IN SAFETY DISPENSER

Blade 18 mm



Total length: 110 mm

Art. no. 0715 66 051 PU/Qty 50

Best compromise between long service life and sharp cutting edge.
Ice hardened cutting edge for high cutting quality.



STAINLESS STEEL CUTTING BLADE WITHOUT BREAK-OFF SEGMENTS

Blade 18 mm



Total length: 110 mm

Art. no. 0715 66 085 PU/Qty 10

Non-rusting blade for permanently clean cuts.



CUTTING BLADES IN DISPENSER

Trapezoidal blade



Total length: 61 mm

Art. no. 0715 66 02

PU/Qty 5 in slide dispenser

Hook blade



Total length: 50 mm

Art. no. 0715 66 03

PU/Qty 5 in slide dispenser

Concave blade



Total length: 59 mm

Art. no 0715 665 23

PU/Qty 10 in slide dispenser

BI-METAL TRAPEZOIDAL BLADE IN DISPENSER

Bi-metal trapezoidal blade



Total length: 61 mm

Extremely safe to use

Unbreakable under normal working conditions

Pliable and flexible

If necessary, the blade can be bent and worked with accordingly

High economy

3 x longer service life

Art. no. 0715 66 021

PU/Qty 10 in slide dispenser

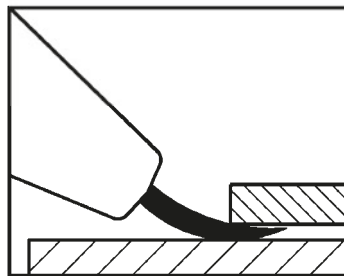

CUTTING BLADES EXTRA LONG

Smooth ground blade



Total length: 180 mm

Art. no. 0715 665 41 PU/Qty 2

Example uses:

Polystyrene

Ground corrugated blade



Total length: 180 mm

Art. no. 0715 665 42 PU/Qty 2

Example uses:

Insulants



JAPANESE SAW BLADE 25 MM

Small, handy, and universal, a genuine mini saw.

- Extremely sharp special teeth for clean and effortless cutting
- Enables parts to be sawed off flush
- The cutting depth of the blade can be adjusted

For solid wood



Total length: 140 mm

Art. no. 0715 66 352 PU/Qty 2

For plastics



Total length: 140 mm

Art. no. 0715 66 353 PU/Qty 2

Example uses:

For use in 25 mm cutter with clamping screw, e.g. cutter 25 mm art. 0715 66 350 - for sawing off strips and roof battens and cutting to length plastic pipes and cable ducts

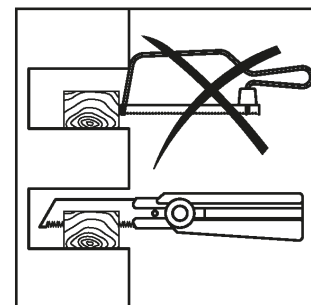
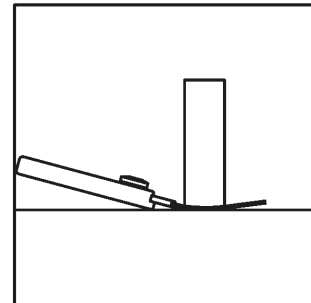
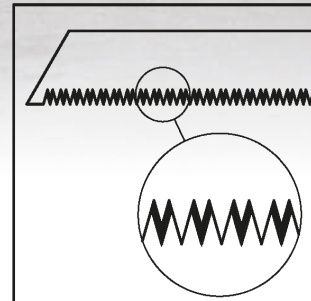

KNIFE POUCHES

Safekeeping during the work.

- Tapering pouch for good knife seat
- Robust cow leather
- Rivet reinforced seams

Small pouch ①

Length: 210 mm

Art. no. 0715 93 737

PU/Qty 1

For cutter/knife

Art. no. 0715 66 01; art no. 0715 66 274;
Art. no. 0715 66 210; art. no. 0715 66 275

Large pouch ②

Length: 200 mm

Art. no. 0715 93 736

PU/Qty 1

For cutter/knife

Art. no. 0715 66 013; art no. 0715 66 015;
Art. no. 0715 66 276; art. no. 0715 66 350



UNIVERSAL KNIFE



NANGCORI STAINLESS STEEL
Art. 0715 66 530

UNIVERSAL KNIFE

Stable cutting blade for flexible, universal use.

- Particularly ergonomic handle shape for various gripping variants
- The 2 mm thick knife blade is integrated securely in the handle
- Including case with belt clip, for optimal safekeeping and protection against accidental injury. The knife engages easily in the case



1C knife

- High quality stainless steel 440 A; good compromise between hardness and corrosion resistance
- Cutting edge hardness: 56 HRC
- Blade length: 100 mm
- Total length: 225 mm

Art. no. 0715 66 542 PU/Qty 1

Example uses:

For opening packaging film and cutting ropes and sacks



2C knife

- Nanokorr stainless steel, extremely corrosion resistant steel of high hardness
- Cutting edge hardness: 58 HRC
- Blade length: 100 mm
- Total length: 220 mm

Art. no. 0715 66 530 PU/Qty 1

Example uses:

For cutting off hoses, ropes, film, and belts



INSULATION KNIFE



INSULATION KNIFE

With faux leather sheath.



Smooth ground knife

- **Blade design:** single edged, smooth
- Blade length: 28 cm
- Stable, handy handle with finger guard

Art. no 0874 110 001

PU/Qty 1

Example uses:

Used for cutting insulations made of:
Natural rubber, PUR, polyethylene, and fleece



Ground corrugated knife

- **Blade design:** double edged, corrugated
- Blade length: 31 cm
- Double-edge blade
- Blade tip suitable for drilling holes
- Stable, handy wooden handle

Art. no 0874 110 004

PU/Qty 1

Example uses:

Used for cutting insulations made of:
Mineral wool (laminated/unlaminated), with hard outer jacket



SCRAPER



SCRAPER AND KNIFE SET

27 piece scraper set with 4 scraper blades and one carpet knife.

- 2C scraper handle with blade clamping
- Carpet knife with locking at 4 places
- In robust plastic case



Example uses:

For removing adhesive bead residue, seals, adhesive labels, paint residue, etc.



Scope of delivery:

- 1x art. 0715 66 01 carpet knife
- 5x art. 0715 66 02 trapezoidal blades
- 1x art. 0715 66 41 scraper handle
- 5x art. 0715 66 042 scraper blade 12 mm straight
- 5x art. 0715 66 043 scraper blade 16 mm straight
- 5x art. 0715 66 044 scraper blade 20 mm straight
- 5x art. 0715 66 045 scraper blade 16 mm slanted

Art. no. 0715 66 40 PU/set 1

BLADE SCRAPER

With ergonomic, non-slip 2C handle.

- Robust stainless steel blade holder
- Detachable blade guard
- Including 6 scraper blades



- Scraper width: 40 mm
- Length: 180 mm

Art. no. 0714 663 35

PU/set 1

Compatible blade:



Scraper blade

Art. no 0714 663 351

PU/Qty 10

Example uses:

For removing labels, stickers, adhesive residue, etc.



GLASS SCRAPER

Simple scraper for removing residue and soiling.

- Plastic handle with blade cover
- Scraper width 58 mm



Art. no. 0715 66 08

PU/Qty 1

Example uses:

Adhesive labels and adhesive residue on glass surfaces



PLASTIC SCRAPER SET

Gentle removal of stickers, adhesive labels, and soiling.

- Small risk of injury
- Robust, regrindable blade



- Scraper width: 22 mm

Scope of delivery:

Scraper long 200 mm, art. no. 0714 541 223

Scraper short 155 mm, art. no. 0714 541 224

Art. no. 0714 541 225

PU/set 1

Example uses:

Paint residue, foam residue, adhesive labels

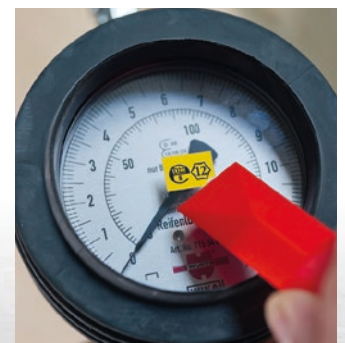
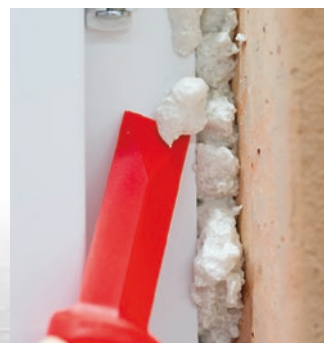

CUSTOMER CONTACT POINTS

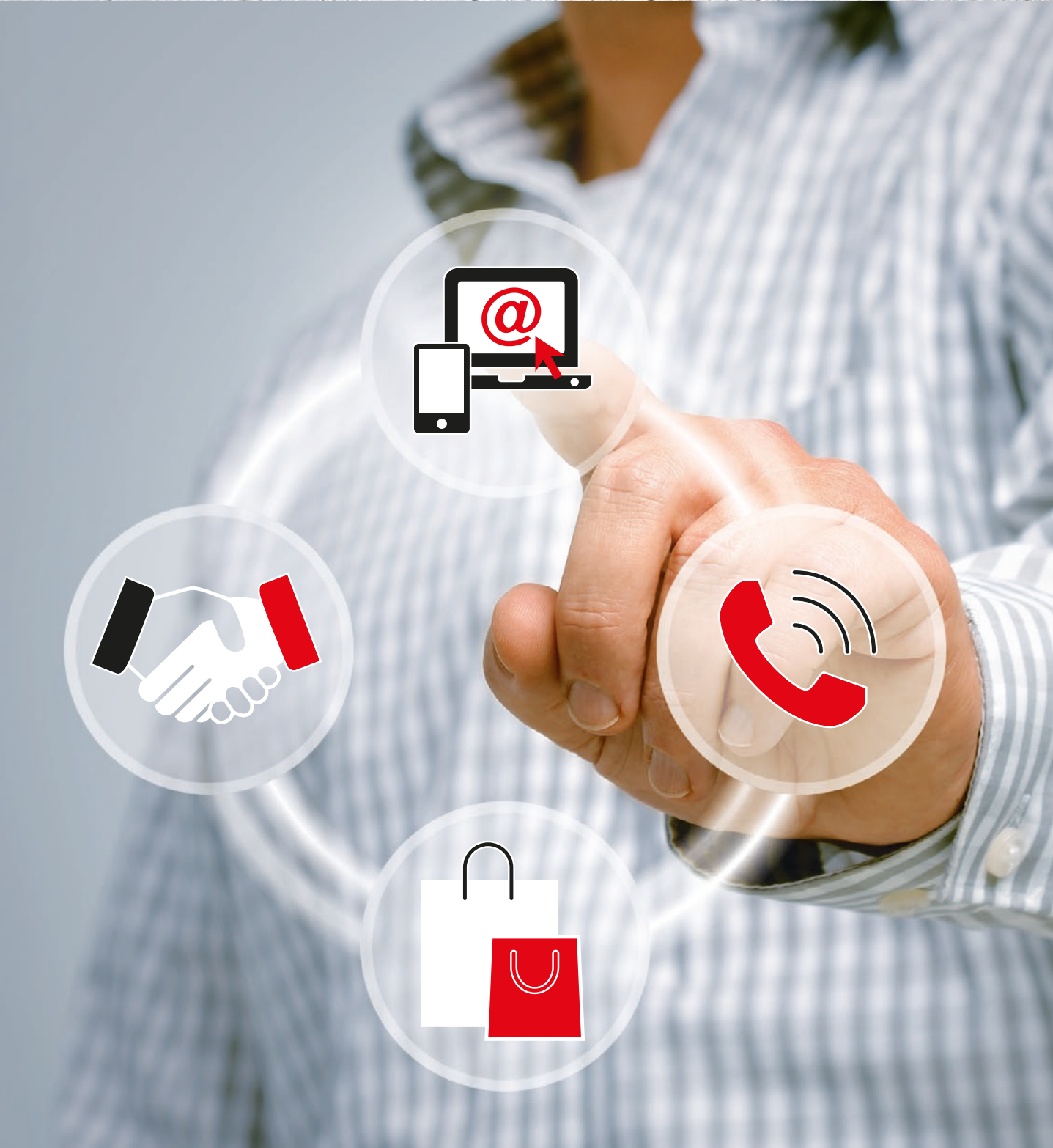

CUTTER, KNIVES AND ACCESSORIES

Wuerth Industrial Services Malaysia Sdn. Bhd.

Lot 806, Jalan Subang 5
Taman Perindustrian Subang
47600 Subang Jaya, Selangor
Phone +60 3 8021 0200
info@wuerth-industry.my
www.wuerth.my

Reproduction only with permission.

MWC - DNP - 04/19

Printed on environmentally friendly paper.

We reserve the right to make any changes we deem necessary to improve the quality of the product, even without prior announcement or notification. Illustrations may be example illustrations that may differ in appearance from the goods supplied. Errors excepted. We accept no liability for

any printing errors. Our general terms and conditions apply.

