

Wuerth Industrial Services Malaysia

HAND TOOL RANGE

2019 / 2020





FOAM SETS

4 - 15



SOCKET SETS

16 - 25



SPANNER SETS

26 - 30



SCREWDRIVER SETS

31 - 38



BIT SETS

39 - 41



PLIER SETS

42 - 48

FOAM SETS



Foam Size Guide

Size	Example	Dimensions
FS1	0965 900 904	333 x 94mm
FS2	0965 900 501	333 x 188mm
FS3	0965 900 402	333 x 376mm
FS4	0965 900 945	333 x 470mm

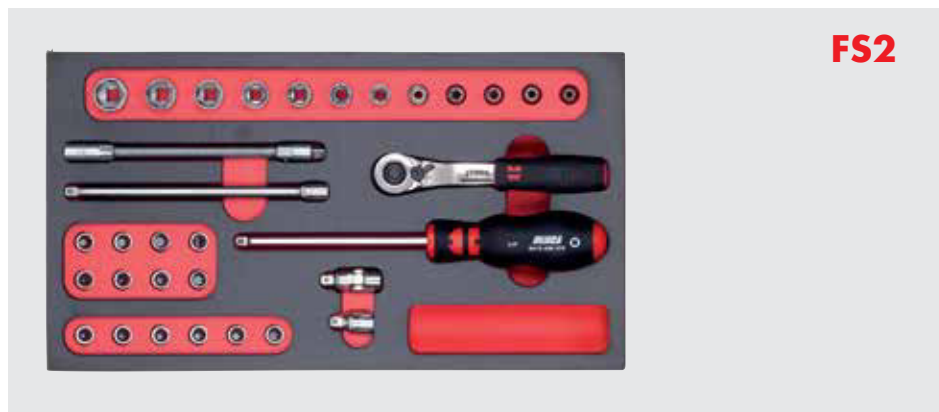

FS2

1/4" Socket Set - 32pcs

Contents:

1/4" Ratchet, Angled Extension 25 mm, Extension 150 mm, Flexible Extension 150 mm, Cardan Joint, Screwdriver handle 1/4"
 12 Hex Sockets: 4, 5, 5.5, 6, 7, 8, 9, 10, 11, 12, 13 and 14 mm
 14 Sockets, bits: PH 1, PH 2, PH 3; Allen Head: 4, 5, 6; TX 10, 15, 20, 25, 27, 30, 40; slot 0.8x5.5

Art. No. 0965 900 941



FS2

1/4" Socket Set - 33pcs

Contents:

1/4" Ratchet, Extension 100 and 150 mm, Cardan Joint, Adapter with Quick-Change Chuck, Screwdriver handle 1/4"
 12 Hex Sockets: 4, 5, 5.5, 6, 7, 8, 9, 10, 11, 12, 13 and 14mm
 15 Bits: PH1, 2, 3, PZ3, TX10, 15, 20, 25, 27, 30, 40, Allen Head: 3, 4, 5, 6.

Art. No. 0965 900 001

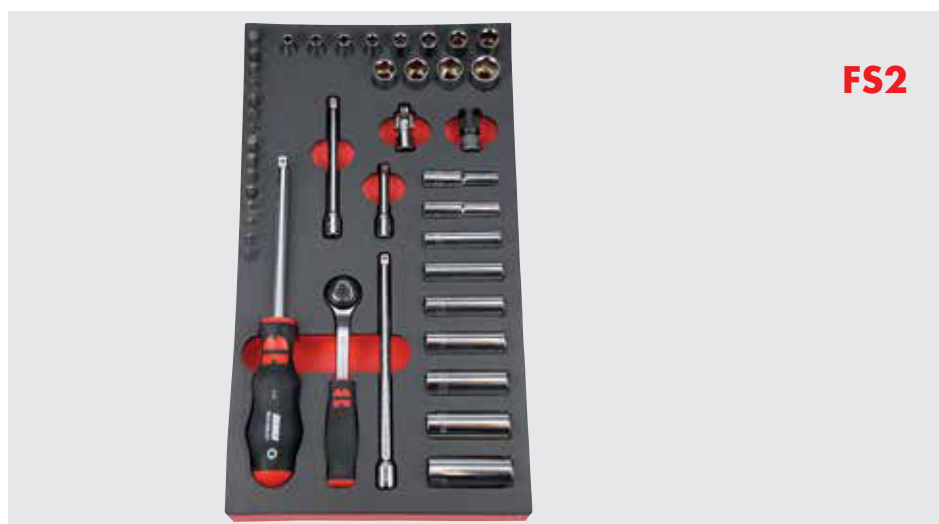

FS2

1/4" Socket Set - 43pcs

Contents:

1/4" Ratchet, Extension 53, 100 and 150mm, Cardan Joint, Adapter with Quick-Change Chuck, Screwdriver handle 1/4"
 12 Hex Sockets, Short: 4, 5, 5.5, 6, 7, 8, 9, 10, 11, 12, 13 and 14mm
 9 Hex Sockets, long: 6, 7, 8, 9, 10, 11, 12, 13 and 14mm
 15 Bits: PH1, 2, 3, TX10, 15, 20, 25, 27, 30, 40, Allen Head: 3, 4, 5, 6. Slotted 0.8x5.5mm

Art. No. 0965 900 002

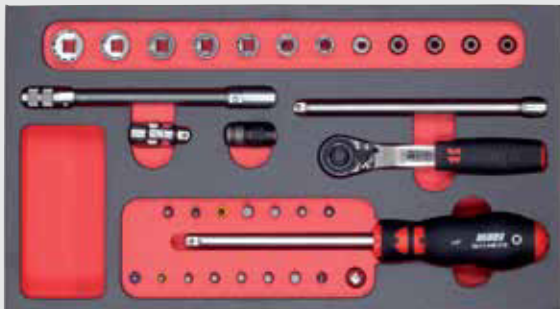

FS2

1/4" Multi Socket Set 34pcs

Contents:
 1/4" Ratchet, Angled Extension 25 mm, Extension 150 mm, Flexible Extension 150 mm, Cardan Joint, 1 screwdriver handle 1/4", Adapter with Quick-Change Chuck
 12 Multi Sockets: 4, 5, 5.5, 6, 7, 8, 9, 10, 11, 12, 13 and 14 mm
 15 bits: PH 1, PH 2, PH 3; Allen Head: 3, 4, 5, 6; TX 10, 15, 20, 25, 27, 30, 40; slot 0.8x5.5

Art. No. 0965 900 942



FS5

3/8" Socket Set - 42pcs

Contents:
 3/8" Ratchet, Extension 75 and 250 mm, Cardan Joint, 14 Hex Sockets: 8, 9, 10, 11, 12, 13, 14, 15, 16, 17, 18, 19, 21, 22mm
 8 Long Hex Sockets: 8, 10, 13, 16, 17, 18, 19, 21 mm
 8 Sockets External TX E5, 6, 7, 8, 10, 11, 12, 14
 8 Sockets Internal TX 15, 20, 25, 27, 30, 40, 45, 50

Art. No. 0965 900 101

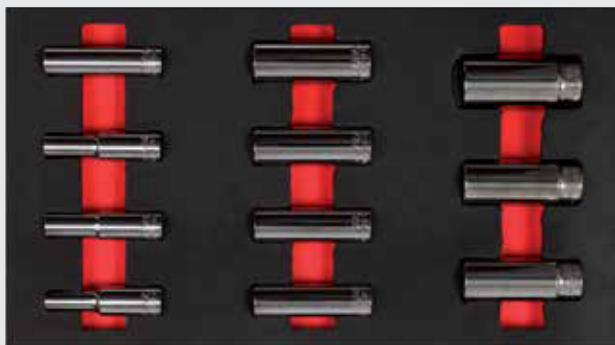

FS2

3/8" Socket Set - 11pcs

Contents:
 11 Hex Sockets, Long; 8, 9, 10, 12, 13, 14, 16, 17, 18, 19 and 22mm

Art. No. 0965 900 307



FS4

1/2" Socket Set - 23pcs

Contents:
 1/2" Ratchet, Extension: 125 and 250 mm, Cardan Joint, 19 Hex Sockets: 10, 11, 12, 13, 14, 15, 16, 17, 18, 19, 20, 21, 22, 24, 26, 27, 28, 30, 32mm.
 Empty compartment for loading with 1/4" assortments.

Art. No. 0965 900 202



FS2

1/2" Socket Set - 23pcs

Contents:
1/2" Ratchet, Extension: 125 and 250 mm,
Cardan Joint, 19 Hex Sockets: 10, 11, 12, 13,
14, 15, 16, 17, 18, 19, 20, 21, 22, 24, 26, 27,
28, 30, 32mm.

Art. No. 0965 900 208



FS4

1/2" Socket Set - 24pcs

Contents:
1/2" Ratchet, Angle Extension 53mm,
Extension 125mm and 250mm, Cardan Joint
19 Hex Sockets: 10, 11, 12, 13, 14, 15, 16,
17, 18, 19, 20, 21, 22, 24, 26, 27, 28, 30 and
32mm

Art. No. 0965 900 945

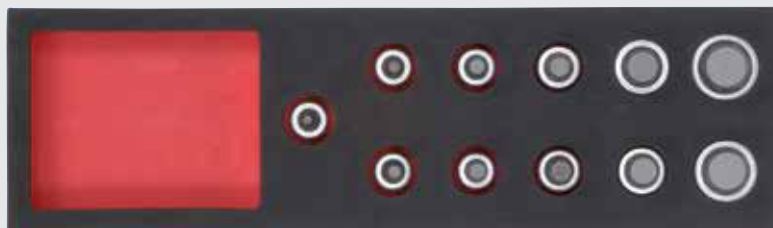

FS1

1/2" Socket Set, Allen Heads - 11pcs

Contents:
Allen Heads: 4 x 60, 5 x 60, 6 x 60,
7 x 60, 8 x 60, 9 x 60, 10 x 60, 12 x 60,
14 x 60, 17 x 60, 19 x 60mm

Art. No. 0965 900 204



FS2

1/2" Socket Set - 13pcs

Contents:
Allen Heads: 5 x 180, 6 x 140, 7 x 100, 8 x 80
and 10 x 140mm
Torx: TX40 x 120, TX45 x 120, TX50 x 120,
TX55 x 140 and TX70 x 140mm
Spline: M8 x 100, M10 x 100 and M12 x
100mm

Art. No. 0965 900 205



FS1

1/2" Socket Set, Internal/ External TX-17pcs

Contents:
Inner TX: 20, 25, 27, 30, 40, 45, 50, 55, 60.
Outer TX: E10, 11, 12, 14, 16, 18, 20, 24.

Art. No. 0965 900 201

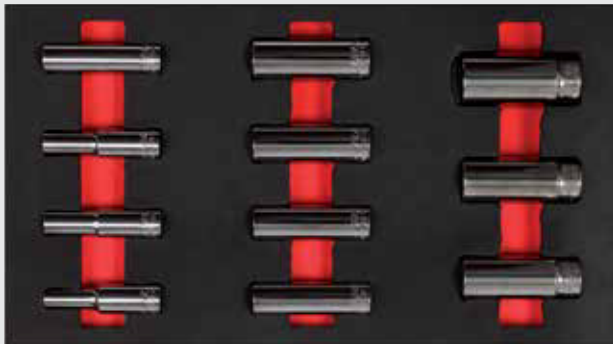

FS2

1/2" Socket Set - 11 pcs

Contents:
11 Hex Sockets, Long; 13, 14, 16, 17, 18, 19,
22, 24, 27, 30 and 32mm

Art. No. 0965 900 206



FS1

1/2" Socket Set , Impact - 6pcs

Sizes 17, 19 and 21mm

Art. No. 0965 900 212



FS1

1/4 & 3/8" Socket Set, Imperial - 26pcs

Contents (3/8"):
15 Hex Sockets, Imperial: 1/4, 9/32, 5/16,
11/32, 3/8, 7/16, 1/2, 9/16, 19/32, 5/8,
11/16, 3/4, 25/32, 13/16, 7/8.

Contents (1/4"):
15 Hex Sockets, Imperial: 5/32, 3/16, 7/32,
1/4, 9/32, 5/16, 11/32, 3/8, 7/16, 1/2,
9/16.

Art. No. 0965 900 905



FS1

1/4" & 3/8" Socket Set, Mix - 22pcs

Contents (3/8"): Allen Head Sockets: 3, 4, 5, 6, 7, 8, 9, 10 mm.

Quick-change chuck.

Contents (1/4"):

Allen Head Sockets: 3, 4, 5, 6, 8 mm.

Slotted Sockets: 0.6 x 3.5, 1.0 x 5.5, 1.2 x 6.5, 1.2 x 8.0.

PH Sockets: 1, 2, 3. Quick-change chuck.

Art. No. 0965 900 904

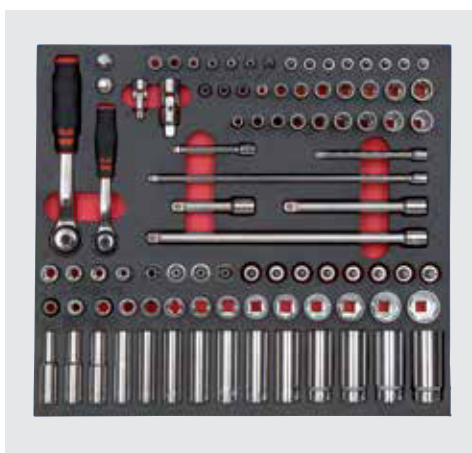

1/4" & 3/8" Socket Set, Mix - 91pcs

Contents:

1/4" Contents: 1/4" Ratchet, Extension 75, 100 and 250mm, Cardan Joint

11 Hex Sockets, Short; 5, 5.5, 6, 7, 8, 9, 10, 11, 12, 13 and 14mm

9 Hex Sockets, Long; 6, 7, 8, 9, 10, 11, 12, 13 and 14mm

8 Sockets, Internal TX; 8, 9, 10, 15, 20, 25, 30 and 40

7 Sockets, External TX; E4, 5, 6, 7, 8, 10 and 11

3/8" Contents: 3/8" Ratchet, Extension 75, 125 and 250mm, Cardan Joint

14 Hex Sockets, Short; 8, 9, 10, 11, 12, 13, 14, 15, 16, 17, 18, 19, 21 and 22mm

14 Hex Sockets, Long; 8, 9, 10, 11, 12, 13, 14, 15, 16, 17, 18, 19, 21 and 22mm

Sockets, Internal TX; 15, 20, 25, 30, 40, 45 and 50

8 Sockets, External TX; E5, 6, 7, 8, 10, 11, 12 and 14

Art. No. 0965 900 903

FS4



FS5

1/4" & 1/2" Socket Set - 59pcs

Contents:

1/2" assortment,

Art. No. 0965 13 230

1/4" assortment,

Art. No. 0965 11 32

Art. No. 0965 900 901



FS1

Magnetic Extension Set - 6pcs

Contents;

1/4" 50mm, 1/4" 100mm, 3/8" 50mm, 3/8"

125mm, 1/2" 75mm and 1/2" 150mm.

Features a magnetic end to retain the fastener being tightened or loosened.

Art. No. 0965 900 940



FS2

Combination Spanner Set - 11 pcs

Contents:
Sizes: 8, 9, 10, 11, 12, 13, 14, 15, 17, 19 and 22mm.

Art. No. 0965 900 403



FS2

Combination Spanner Set - 17 pcs

Contents:
Sizes: 6, 7, 8, 9, 10, 11, 12, 13, 14, 15, 16, 17, 18, 19, 20, 21 and 22mm.

Art. No. 0965 900 401



FS3

Combination Spanner Set - 10 pcs

Contents:
Sizes: 23, 24, 25, 26, 27, 28, 29, 30, 32 and 34mm.

Art. No. 0965 900 402



FS2

Double Open Ended Spanner Set - 8 pcs

Contents:
Sizes: 6 x 7, 8 x 9, 10 x 11, 12 x 13, 14 x 15, 16 x 17, 18 x 19 and 20 x 22mm.

Art. No. 0965 900 404



FS3

Offset Ring Spanner Set - 12pcs

Contents:

Sizes: 6 x 7, 8 x 9, 10 x 11, 12 x 13, 14 x 15, 16 x 17, 18 x 19, 20 x 22, 21 x 23, 24 x 27, 25 x 28, 30 x 32.

Art. No. 0965 900 405



FS2

Flexible Head Ratchet Combination Spanner Set - 6pcs

Contents:

Sizes: 8, 10, 12, 13, 17 and 19mm

Art. No. 0965 900 410



FS2

Flexible Head Ratchet Combination Spanner Set - 12pcs

Contents:

Sizes: 8, 9, 10, 11, 12, 13, 14, 15, 16, 17, 18 and 19mm

Art. No. 0965 900 412

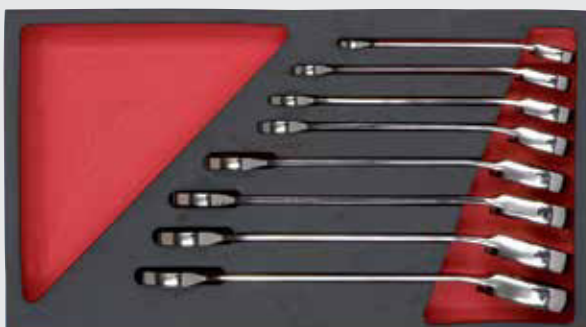

FS2

Multi Ratchet Combination Set - 6pcs

Content:

Sizes: 8, 10, 12, 13, 17, 19mm

Art. No. 0965 900 406



FS2



Screwdriver Set, Hex Blade, PH & Slotted - 8pcs

Contents:
Screwdrivers with continuous hex. head blade and striking cap 0.6 x 3.5, 0.8 x 4.5, 1.2 x 7.0, 1.6 x 9.0, PH1, PH2
Screwdrivers, Stubby PH1, PH2.

Art. No. 0965 900 501



FS2



Screwdriver Set, Hex Blade, PH & Slotted - 8pcs

Contents:
Screwdrivers with hex. head blade 0.6 x 3.5, 1.0 x 5.5, 1.2 x 6.5, 1.6 x 8.0, PH1, PH2
Screwdrivers, Stubby PH1, PH2.

Art. No. 0965 900 504



FS2



Screwdriver Set, Round Blade, PH & Slotted - 8pcs

Contents:
Slotted; 0.6 x 3.5 x 100, 1.0 x 5.5 x 125, 1.2 x 6.5 x 150, 1.2 x 8.0 x 175, PH1, PH2.
Screwdrivers, Stubby PH1, PH2.

Art. No. 0965 900 505



FS2



Screwdriver Set, Round Blade, TX-7pcs

Contents:
TX 10, 15, 20, 25, 27, 30 and 40.

Art. No. 0965 900 502



FS3



T-Handle Screwdriver Set, Hex - 6pcs

Contents:

Sizes: 2.5, 3, 4, 5*, 6*, and 8mm*

* with ball head

Art. No. 0965 900 510

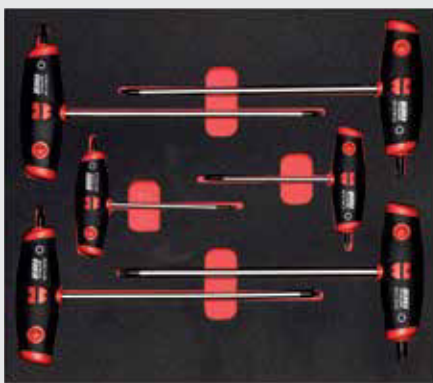

FS3



T-Handle Screwdriver Set, TX- 6pcs

Contents:

TX 10, 15, 20, 25, 27, 30 and 40.

Art. No. 0965 900 511



FS2

Bit Assortment - 47pcs

Contents:

Adapter for 3/8" ratchet, 29 mm,

Adapter for 1/2" ratchet, 37 mm,

TX bits with bore, 30 mm: TX 20, 25, 27, 30, 40, 45, 50, 55.

TX bits, 75 mm: TX 20, 25, 27, 20, 40, 45, 50, 55.

Allen head bit, 30 mm: 5, 6, 7, 8, 10 mm.

Spline multipoint bit, 30 mm: M 5, 6, 8, 10, 12.

Spline multipoint bit, 75 mm: M 6, 8, 10, 12.

RI bit, 30 mm: RI 5, 6, 7, 8, 9, 10, 12, 13, 14.

RI bit, 75 mm: RI 5, 6, 8, 10.

PH 2, 30 mm and PH 3, 30 mm.

Art. No. 0965 900 906

FS2



Ratchet Bit Assortment, 10mm - 38pcs

Contents:

10mm Bit Ratchet,

Adapter for 1/2" Ratchet, 37 mm,

TX bits with bore, 30 mm: TX 20, 25, 27, 30, 40, 45, 50, 55.

TX bits, 75 mm: TX 20, 25, 27, 30, 40, 45, 50, 55.

TX bits, 120 mm: TX 40, 45, 50.

Allen Head bit, 30 mm: 5, 6, 7, 8, 10, 12 mm.

Spline, 30 mm: M 5, 6, 8, 10, 12.

Spline, 75 mm: M 6, 8, 10, 12.

PH 2, 30 mm and PH 3, 30 mm.

Art. No. 0965 900 907

FS2



Pliers Set, 4pcs

Contents:

Combination Pliers 180mm

Water Pump Pliers 250mm

Snipe Nose Pliers 210mm

Power Side Cutters 160mm

Art. No. 0965 900 600

FS2

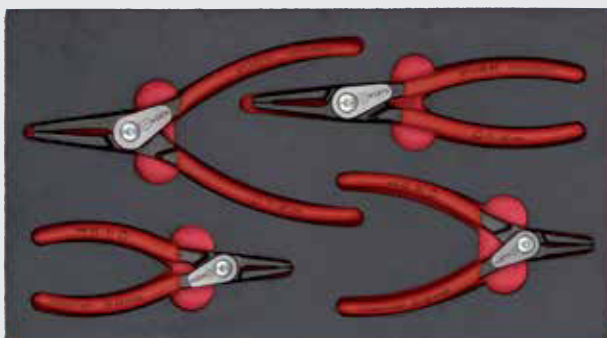

Circlip Pliers Assortment - 4pcs

Contents:

12 - 25 mm Internal Straight

19 - 60 mm Internal Straight

19 - 60 mm External Straight

10 - 25 mm External Straight

Art. No. 0965 900 603

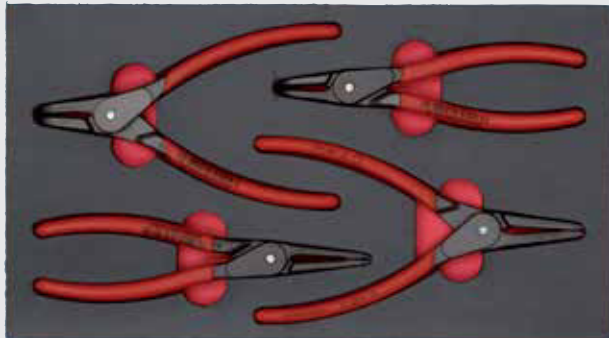

Circlip Pliers Assortment - 4pcs

Contents:

- 12 - 25 mm Internal Bent
- 19 - 60 mm Internal Bent
- 19 - 60 mm External Bent
- 10 - 25 mm External Bent

Art. No. 0965 900 604



Circlip Pliers Assortment - 4pcs

Contents:

- 19 - 60 mm Internal Straight
- 19 - 60 mm Internal Bent
- 19 - 60 mm External Straight
- 19 - 60 mm External Bent

Art. No. 0965 900 655





SOCKET SETS



Mutli Sockets

Art. No. 0965 11 23

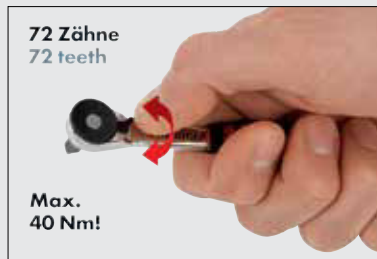

Hex Sockets

Art. No. 0965 11 023

1/4 Multi Socket Set, Mini - 23pcs

Extremely compact special tools with bit ratchet, multi sockets and adapter for use in the tightest of spaces.

Contents:

1/4" Bit Ratchet, Magnetic Bit Holder 100mm, 1/4" Socket Adaptor 25 and 100mm 6 Sockets; 5, 6, 8, 10, 11 and 13mm Bits; PH1, PH2, TX10, 15, 20, 25, 27, 30, Hex 3, 4,5 and 6mm, Slotted 0.8x5.5mm



1/4 Socket Set, Ball Head - 27pcs

Multi-functional spherical ratchet with adjustable handle and the most commonly used socket wrenches in a compact product range. 3 in 1! Can be used like a conventional ratchet, as a screwdriver or a T-handle.

Art. No. 0965 014 27

Contents	Length in mm	Art. No.	P. Qty.
Spherical Head Ratchet	145	0712 014 05	1
9 Socket Wrench Inserts: One each of 6; 7; 8; 9; 10; 11; 12; 13; 14	22	0713 111 106-0713 111 114	
14 Socket Wrench Insert Bits: PH 1; PH 2; PH 3 25	25	0715 118 01-0715 118 03	
Internal hex.: 4; 5; 6	25	0715 115 03-06	
TX: 10, 15, 20, 25, 27, 30, 40	25	0715 113 10-40	
Slotted: 1.0 x 5.5	25	0715 117 55	
Extensions	50; 150	0715 118 102-116	
Cardan Joint	33	0713 118 301	



1/4" Socket Set - 16pcs

Contents:

1/4" Ratchet, Extension 100mm and 150mm, Cardan Joint 12 Hex Sockets; 4, 5, 5.5, 6, 7, 8, 9, 10, 11, 12, 13 and 14 mm

Art. No. 0965 11 16



1/4" Socket Set - 32pcs

Contents:

1/4" Ratchet, Angled Extension 25 mm, Extension 150 mm, Flexible Extension 150 mm, Cardan Joint, Screwdriver handle 1/4"
 12 Hex Sockets: 4, 5, 5.5, 6, 7, 8, 9, 10, 11, 12, 13 and 14 mm
 14 Sockets, bits: PH 1, PH 2, PH 3; Allen Head: 4, 5, 6; TX 10, 15, 20, 25, 27, 30, 40; slot 0.8x5.5

Art. No. 0965 014 32



1/4 Socket Set - 33pcs

Contents:

1/4" Ratchet, Extension 100mm and 150 mm, Cardan Joint, Screwdriver handle 1/4", Adapter with Quick Change Chuck
 12 Hex Sockets; 4, 5, 5.5, 6, 7, 8, 9, 10, 11, 12, 13, 14 mm,
 15 bits: PH1, PH2, PH3,
 Slot: 0.8 x 5.5; Allen Head: 3, 4, 5, 6mm
 Torx: TX 10, 15, 20, 25, 27, 30, 40

Art. No. 0965 11 32



1/4" Socket Set - 42pcs

Contents:

1/4" Ratchet, Extension 100 mm and 150 mm, Cardan Joint, Screwdriver handle 1/4", Adapter with Quick-Change Chuck
 12 Hex Sockets, Short; 4, 5, 5.5, 6, 7, 8, 9, 10, 11, 12, 13, 14 mm
 9 Hex Sockets, Long; 6, 7, 8, 9, 10, 11, 12, 13, 14 mm
 15 Bits: PH 1, 2, 3, Slotted 0.8 x 5.5 mm
 Allen Head; 3, 4, 5, 6 mm
 TX 10, 15, 20, 25, 27, 30, 40

Art. No. 0965 11 42





1/4" Multi Socket Set - 33pcs

Contents:

1/4" Ratchet, Angled Extension 100mm and 150 mm, Cardan Joint, 1 screwdriver handle 1/4", Adapter with Quick-Change Chuck
 12 Multi Sockets: 4, 5, 5.5, 6, 7, 8, 9, 10, 11, 12, 13 and 14 mm
 14 bits: PH 1, PH 2, PH 3; Allen Head: 3, 4, 5, 6; TX 10, 15, 20, 25, 30, 40; slot 0.8x5.5

Art. No. 0965 11 032

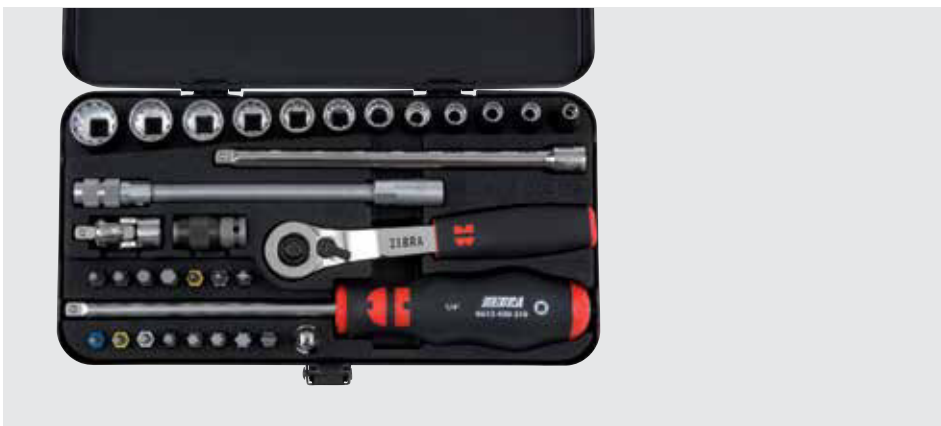

1/4" Multi Socket Set - 34pcs

Contents:

1/4" Ratchet, Angled Extension 25 mm, Extension 150 mm, Flexible Extension 150 mm, Cardan Joint, 1 screwdriver handle 1/4", Adapter with Quick-Change Chuck
 12 Multi Sockets: 4, 5, 5.5, 6, 7, 8, 9, 10, 11, 12, 13 and 14 mm
 15 bits: PH 1, PH 2, PH 3; Allen Head: 3, 4, 5, 6; TX 10, 15, 20, 25, 27, 30, 40; slot 0.8x5.5

Art. No. 0965 014 34



1/4" Socket Set, Internal/External TX - 20pcs

Contents:

1/4" Ratchet, Extension 100mm, Screwdriver handle 1/4", 1 Cardan Joint
 7 Sockets, External TX; E4, 5, 6, 7, 8, 10, 11
 9 Sockets, Internal TX; TX8, 9, 10, 15, 20, 25, 27, 30, 40

Art. No. 0965 11 180



Socket Set - Go Through - 14pcs

Contents:

Ratchet, Extension 76mm, Adaptor 1/4" and 3/8"
 10 Hex Sockets; 10, 11, 12, 13, 14, 15, 16, 17, 18 and 19mm

Art. No. 0713 130 0



3/8" Socket Set - 16pcs

Contents:

3/8" Ratchet, Extension 125 mm and 250 mm,
Cardan Joint
12 Multi Sockets; 8, 9, 10, 11, 12, 13, 14, 15,
16, 17, 18 and 19 mm

Art. No. 0965 12 160



3/8" Socket Set - 19pcs

Contents:

3/8" Ratchet, Angled Extension 38 mm,
Extension 125 mm and 250 mm, Cardan Joint
14 Hex Sockets: 6, 7, 8, 9, 10, 11, 12, 13, 14,
15, 16, 17, 18 and 19 mm

Art. No. 0965 038 19



3/8" Socket Set - 42pcs

Contents:

3/8" Ratchet, Extension 75mm and 250mm,
Cardan Joint
14 Hex Sockets, Short; 8, 9, 10, 11, 12, 13, 14,
15, 16, 17, 18, 19, 21 and 22 mm
8 Hex Sockets, Long; 8, 10, 13, 16, 17, 18, 19
and 21 mm
8 Sockets, External TX; E5, 6, 7, 8, 10,
11, 12 and 14
8 Sockets Internal TX; 15, 20, 25, 27,
30, 40, 45 and 50

Art. No. 00965 12 42



3/8" Multi Socket Set - 22pcs

Contents:

3/8" Ratchet, Extension 125 and 250mm,
Cardan Joint
17 Multi Sockets; 6, 6.3, 7, 8, 9, 10, 11, 12, 13,
14, 15, 16, 17, 18, 19, 20, 21 and 22mm

Art. No. 0965 12 022



3/8" Socket Set, Internal/ External TX - 19pcs

Contents:
3/8" Ratchet, 175 mm Extension, Cardan Joint
8 Sockets External TX; E5, 6, 7, 8, 10,
11, 12, 14
8 Sockets Internal TX; 15, 20, 25, 27, 30,
40, 45, 50

Art. No. 0965 12 190

3 IN 1

undamaged/intact rounded damaged

Art. No. 0713 124 0

3/8" Socket Rail - 13pcs

Thanks to the new type of profile, this is the troubleshooter and all-rounder for loosening and tightening all common intact, rounded and damaged bolts and nuts.

Contents; 8, 9, 10, 11, 12, 13, 14, 15, 16, 17, 18 and 19mm



1/2" Socket Set - 17pcs

Contents:
1/2" Ratchet, Extension 125mm and 250mm,
Cardan Joint
13 Hex Sockets; 10, 11, 12, 13, 14, 15, 17, 19,
22, 24, 27, 30 and 32 mm

Art. No. 0965 13 170



1/2" Socket Set - 23pcs

Contents:
1/2" Ratchet, Extension 125mm and 250 mm,
Cardan Joint
19 Hex Sockets; 10, 11, 12, 13, 14, 15, 16, 17,
18, 19, 20, 21, 22, 24, 26, 27, 28, 30 and
32mm

Art. No. 0965 13 230



1/2" Socket Set - 24pcs

Contents:
 1/2" Ratchet, Angle Extension 53mm,
 Extension 125mm and 250mm, Cardan Joint
 19 Hex Sockets: 10, 11, 12, 13, 14, 15, 16,
 17, 18, 19, 20, 21, 22, 24, 26, 27, 28, 30 and
 32mm

Art. No. 0965 012 24



1/2" Socket Set - 35pcs

Contents:
 1/2" Ratchet, Extensions 125mm and 250mm,
 Cardan Joint, 3/8" Adaptor
 18 Hex Sockets, Short; 10, 11, 12, 13, 14, 15,
 16, 17, 18, 19, 20, 21, 22, 24, 27, 30, 32 and
 34mm
 10 Hex Sockets, Long; 14, 15, 16, 17, 19, 21,
 22, 24 and 27mm
 2 Spark Plug Sockets; 16 and 21mm

Art. No. 0965 13 35



1/2" Multi Socket Set - 21pcs

Contents:
 1/2" Ratchet, Extension 125mm and 250mm,
 Cardan Joint, T-handle
 15 Multi Sockets; 10, 11, 12, 13, 14, 15, 16,
 17, 18, 19, 22, 24, 27, 30, 32 and 34mm

Art. No. 0965 13 20



1/2" Multi Socket Set - 23pcs

Contents:
 1/2" Ratchet, Extension 125mm and 250 mm,
 Cardan Joint
 19 Multi Sockets; 10, 11, 12, 13, 14, 15, 16,
 17, 18, 19, 20, 21, 22, 24, 26, 27, 28, 30 and
 32mm

Art. No. 0965 13 023



1/2" Socket Set, Internal/ External TX - 21 pcs

Contents:

1/2" Ratchet, Extension 125mm and 250mm,
Cardan Joint
8 Sockets, External TX; E10, 11, 12, 14, 16, 18,
20 and 24
9 Sockets, Internal TX; 20, 25, 27, 30, 40, 45,
50, 55 and 60

Art. No. 0965 13 210



1/2" Socket Set, Mixed - 31 pcs

Contents:

8 Sockets, Internal TX, Short; TX 25, 27, 30, 40,
45, 50, 55 and 60
4 Sockets, Internal TX, Long; TX 30, 40, 50 and
60
4 Sockets, Spline, Short; 5, 6, 8, 10
3 Sockets, Spline, Long; 8, 10, 12
8 Sockets, Allen Head, Short; 5, 6, 7, 8, 10, 12,
14, 17mm
4 Sockets, Allen Head, Long; 6, 8, 10, 12mm

Art. No. 0965 13 310



1/2" Socket Set, Allen Heads - 11 pcs

Contents:

1/2" Ratchet
10 Sockets, Allen Head; 5, 6, 7, 8, 9, 10, 12,
14, 17 and 19mm

Art. No. 0965 13 110



1/2" Socket Set, Impact 4pcs

Contents:
17, 19, 22 and 24mm

Art. No. 0714 13 25



1/2" Socket Set, Impact 3pcs

Contents:
Sizes: 17, 19 and 21mm

Art. No. 0714 130 30



3/4" Socket Set - 15pcs

Contents:
3/4" Ratchet, Extension 200mm and 400mm,
Cardan Joint, T-handle
10 Hex Sockets; 22, 24, 27, 30, 32, 36,
38, 41, 46 and 50 mm.

Art. No. 0965 14 15



3/4" Multi Socket Set - 15pcs

Contents:
3/4" Ratchet, Extension 200mm and 400mm,
Cardan Joint, T-handle
10 Multi Sockets; 22, 24, 27, 30, 32, 36,
38, 41, 46 and 50 mm.

Art. No. 0965 14 150



1/4" & 3/8" Socket Set - 35pcs

Contents 1/4":

1/4" Ratchet, Extension 50mm and 150mm, Cardan Joint
13 Hex Sockets; 4, 5, 5.5, 6, 6.3, 7, 8, 9, 10, 11, 12, 13 and 14 mm

Contents 3/8":

3/8" Ratchet, Extension 75, 125 and 250mm, Cardan Joint
13 Hex Sockets; 10, 11, 12, 13, 14, 15, 16, 17, 18, 19, 20, 21 and 22 mm

Art. No. 0965 17 35



1/4" & 1/2" Socket Set - 56pcs

Contents 1/4": 1/4" Ratchet, Extension 100mm and 150mm, Cardan Joint
12 Hex Sockets; 4, 5, 5.5, 6, 7, 8, 9, 10, 11, 12, 13 and 14mm

Contents 1/2": 1/2" Ratchet, Extension 125mm and 250mm, Cardan Joint
19 Hex Sockets: 10, 11, 12, 13, 14, 15, 16, 17, 18, 19, 20, 21, 22, 24, 26, 27, 28, 30 and 32mm

Screwdriver handle 1/4", Adapter with Quick Change Chuck
15 Bits: PH 1, 2, 3; slotted 0.8 x 5.5 mm;
Allen Heads; 3, 4, 5, 6 mm
TX 10, 15, 20, 25, 27, 30, 40

Art. No. 0965 17 56



1/4" & 1/2" Socket Set - 59pcs

Contents 1/4": 1/4" Ratchet, Angle Extension 25mm, Extension 150mm, Flexible Extension 150mm,
Cardan Joint, Screwdriver Handle 1/4", Adapter with Quick-Change Chuck
12 Hex Sockets: 4, 5, 5.5, 6, 7, 8, 9, 10, 11, 12, 13 and 14mm

15 Bits: PH 1, PH 2, PH 3;
Allen Heads: 3, 4, 5, 6
TX 10, 15, 20, 25, 27, 30, 40;
slot 0.8 x 5.5

Contents 1/2":

1/2" Ratchet, Angle Extension 53mm, Extension 125mm,
Extension 250mm, Cardan joint
19 Hex Sockets: 10, 11, 12, 13, 14, 15, 16, 17, 18,
19, 20, 21, 22, 24, 26, 27, 28, 30 and 32mm

Art. No. 0965 090 59

SPANNER SETS

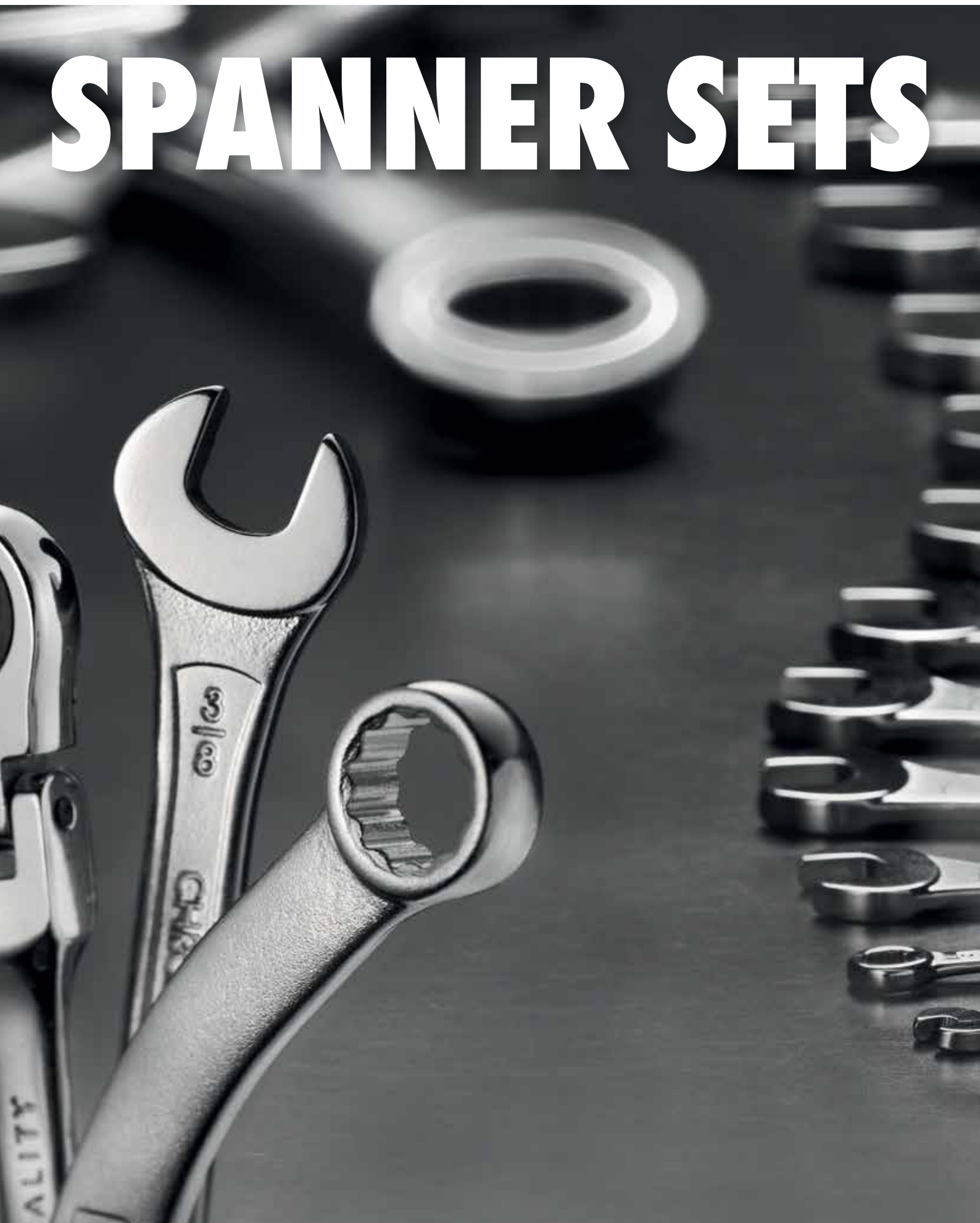

Combination Spanner Sets

Pieces	Contents	Art.No.	Fig
11pcs	8, 9, 10, 11, 12, 13, 14, 15, 17, 19 and 22mm	0713 301 40	1
17pcs	6, 7, 8, 9, 10, 11, 12, 13, 14, 15, 16, 17, 18, 19, 20, 21 and 22mm	0713 301 41	1
27pcs	5.5, 6, 7, 8, 9, 10, 11, 12, 13, 14, 15, 16, 17, 18, 19, 20, 21, 22, 23, 24, 25, 26, 27, 28, 29, 30 and 32mm	0713 301 054	2
28pcs	5.5, 6, 7, 8, 9, 10, 11, 12, 13, 14, 15, 16, 17, 18, 19, 20, 21, 22, 23, 24, 25, 26, 27, 28, 29, 30, 32 and 34mm	0713 301 052	2



Fig 1

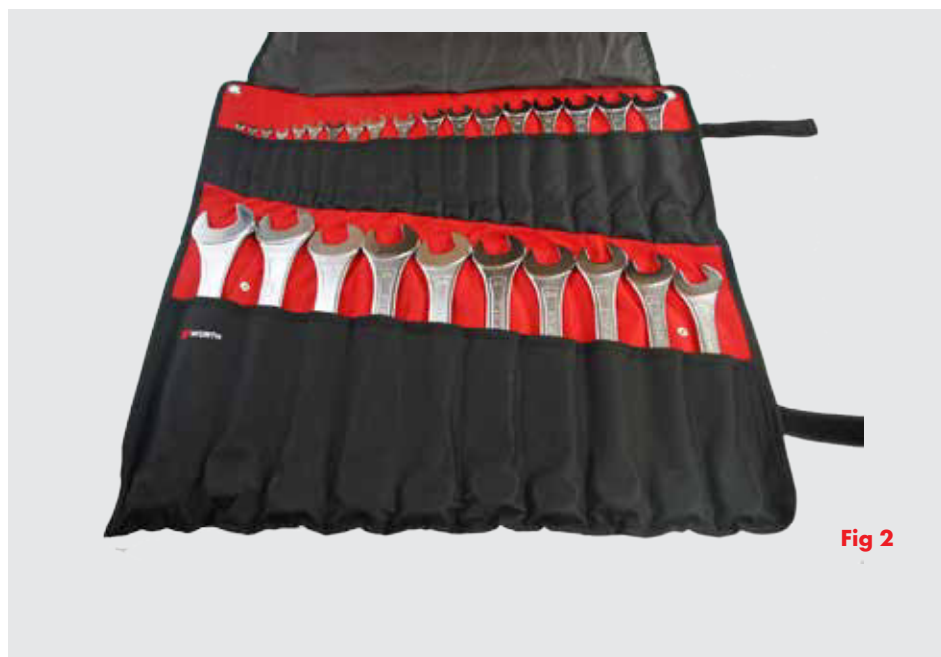

Fig 2



Double Open Ended Spanner Sets



8pcs

Contents:
6x7, 8x9, 10x11, 12x13, 14x15, 16x17,
18x19 and 20x22mm

Art. No. 0713 304 40

10pcs

Contents:
6x7, 8x9, 10x11, 12x13, 14x15, 16x17,
18x19, 20x22, 24x27 and 30x32mm

Art. No. 0713 304 42

10pcs

Contents:
6x7, 8x9, 10x11, 12x13, 14x15, 16x17,
18x19, 20x22, 21x23 and 24x27mm

Art. No. 0713 304 41

12pcs

Contents:
6x7, 8x9, 10x11, 12x13, 14x15, 16x17,
18x19, 20x22, 21x23, 24x27, 25x28 and
30x32mm

Art. No. 0713 304 43

Offset Ring Spanner Set



8pcs

Contents:
6x7, 8x9, 10x11, 12x13, 14x15, 16x17,
18x19 and 20x22mm

Art. No. 0713 305 40

10pcs

Contents:
8x9, 10x11, 12x13, 14x15, 16x17, 18x19,
20x22, 21x23, 24x27 and 30x32mm

Art. No. 0713 305 41

12pcs

Contents:
6x7, 8x9, 10x11, 12x13, 14x15, 16x17,
18x19, 20x22, 21x23, 24x27, 25x28,
30x32mm

Art. No. 0713 305 42

Ratchet Combination Spanner Set



5pcs

Contents:
8, 10, 13, 17 and 19mm

Art. No. 0714 251 100

Multi Ratchet Combination Spanner Set



6pcs

Contents:
8, 10, 12, 13, 17 and 19mm

Art. No. 0714 256 50

Multi-profile, that fits on the five most common bolt head drives! Hex metric, square metric, double-hex metric, hex inch, outer TX.



Flexible Head Ratchet Combination Spanner Sets



6pcs

Contents:
8, 10, 12, 13, 17 and 19mm

Art. No. 0714 253 50



9pcs

Contents:
8, 10, 12, 13, 17, 19, 21, 22 and 24mm

Art. No. 0714 253 52



Ratchet Combination Spanner Set - 6pcs

Contents:
8, 10, 12, 13, 17, 19mm

Art. No. 0714 259 50



4 in 1 Reversible Ratchet Spanner Set

Contents:
8x10 + 12x13, 16x17 + 18x19,
Bit Adapter, 10mm x 1/4"

Art. No. 0714 257 30

SCREWDRIVER SETS





Screwdriver Set, Hex Blade, Striking Cap, PH & Slotted - 5pcs

Contents:
Slotted; 1.0 x 5.5 x 100, 1.2 x 7.0 x 125, 1.6 x 9.0 x 150, PH1, PH2

Art. No.0613 932 25



Screwdriver Set, Hex Blade, Striking Cap, PH & Slotted - 8pcs

Contents:
Slotted; 1.0 x 5.5 x 100, 1.2 x 7.0 x 125, 1.6 x 9.0 x 150, 1.0 x 5.5 x 25 (Stubby, PH1, PH2, PH3 and PH2 (Stubby)

Art. No. 0613 940 81



Screwdriver Set, Hex Blade, PH & Slotted - 6pcs

Contents:
Slotted; 0.6 x 3.5 x 75, 1.0 x 5.5 x 100, 1.2 x 6.5 x 125, 1.6 x 8.0 x 150, PH1, PH2

Art. No. 0613 942 26



Screwdriver Set, Hex Blade, PZ & Slotted - 5pcs

Contents:
Slotted; 0.6 x 3.5 x 75, 1.0 x 5.5 x 100, 1.2 x 6.5 x 125, PZ1, PZ2

Art. No. 0613 942 35



Screwdriver Set, Hex Blade, PZ, PH & Slotted - 6pcs

Contents:
Slotted; 0.6 x 3.5 x 80, 1.2 x 6.5 x 125, PH1, PH2, PZ1 and PZ2

Art. No. 0613 942 44

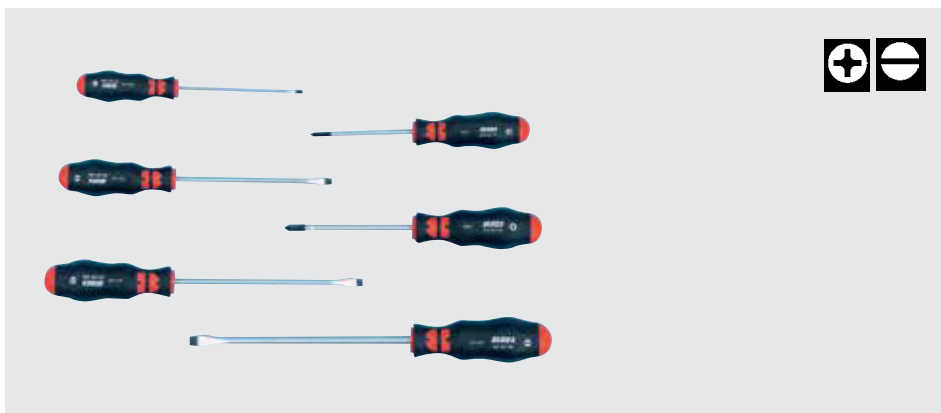

Screwdriver Set, Round Blade, PH & Slotted - 6pcs

Contents:
Slotted; 0.6 x 3.5 x 100, 1.0 x 5.5 x 125, 1.2 x 6.5 x 150, 1.2 x 8.0 x 175, PH1, PH2

Art. No. 0613 923 26

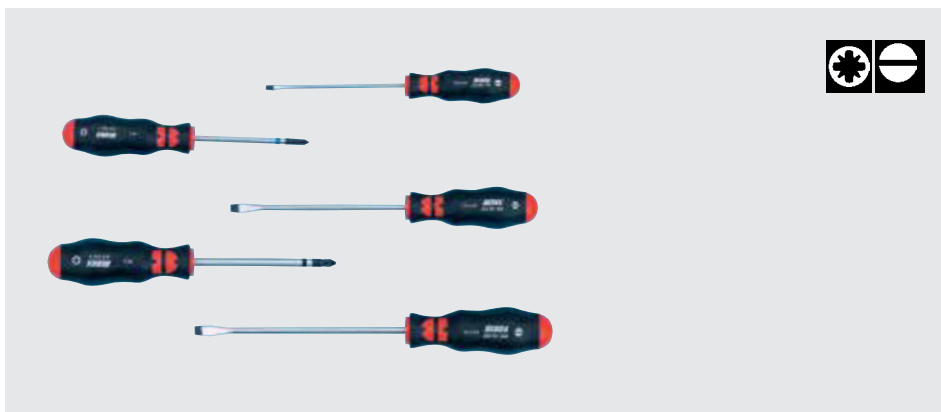

Screwdriver Set, Round Blade, PZ & Slotted - 5pcs

Contents:
Slotted; 0.6 x 3.5 x 100, 1.0 x 5.5 x 125, 1.2 x 6.5 x 150, PZ1, PZ2

Art. No. 0613 923 35

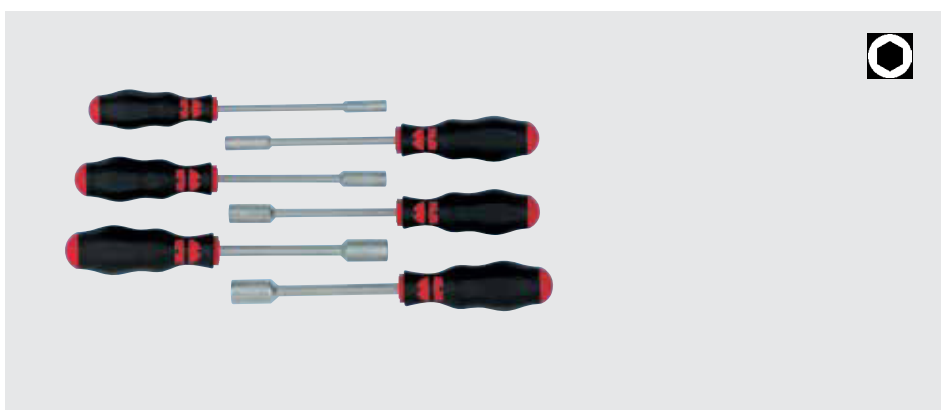

Screwdriver Set, Ex Hex - 6pcs

Contents:
6, 7, 8, 10, 12 and 13mm

Art. No. 0613 936 6



Screwdriver Set, Ex Hex, Flexi - 5pcs

Contents:
6, 7, 8, 10 and 13mm

Art. No. 0613 986 5

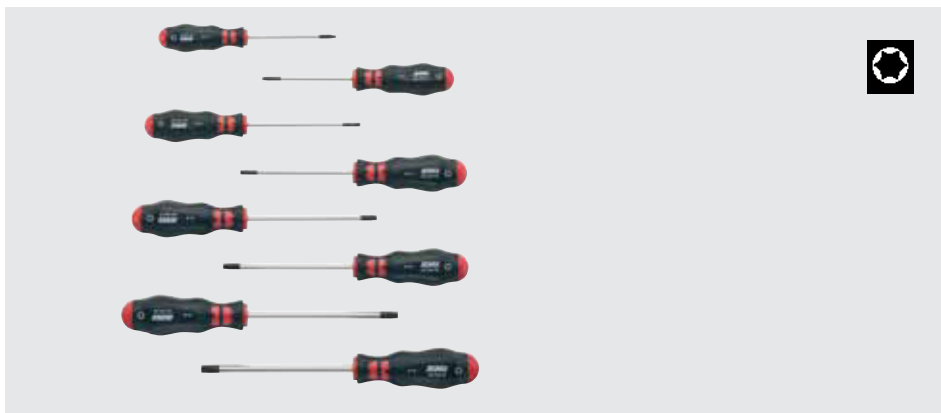

Screwdriver Set, Round Blade, TX - 8pcs

Contents:
TX10, TX15, TX20, TX25, TX27, TX30, TX40 and TX45

Art. No. 0613 934 8

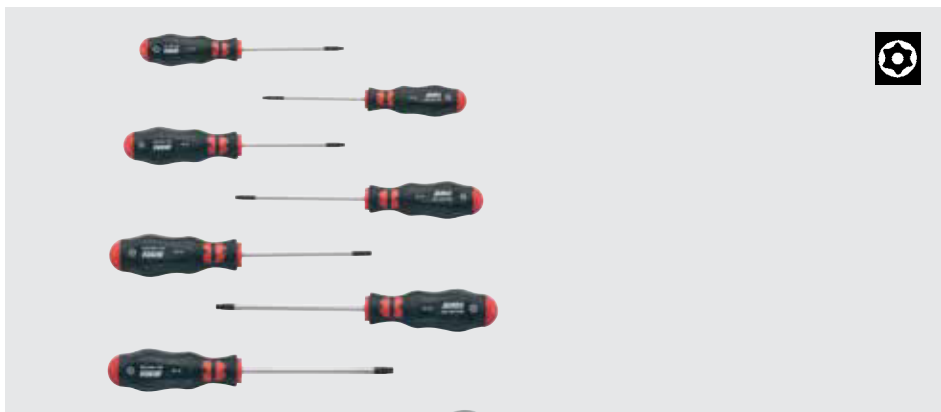

Screwdriver Set, Round Blade, TX with hole - 7pcs

Contents:
TX10, TX15, TX20, TX25, TX27, TX30 and TX40

Art. No. 0613 934 87

VDE SCREWDRIVERS



VDE Screwdriver Set, PH & Slotted - 5pcs

Contents:
Slotted; 0.4 x 2.5 x 80, 0.8 x 4.0 x 100, 1.2 x 6.5 x 150, PH 1 and PH 2

Art. No. 0613 963 25



VDE Screwdriver Set, Slim, PH & Slotted - 5pcs

Contents:

Slotted; 2.5, 4.0 and 6.5mm
PH1 and PH2

Extra Slim design. Ideal for switch and junction boards, circuit breakers, terminal blocks and relays.

Features:

- Insulation with reduction of the blade diameter in the critical working area.
- Enables easy reach of low-lying fastening and spring elements. The fraying of the insulation is avoided.
- Imprinted screw symbol on the handle end for quick identification.

Art. No. 0613 631 001

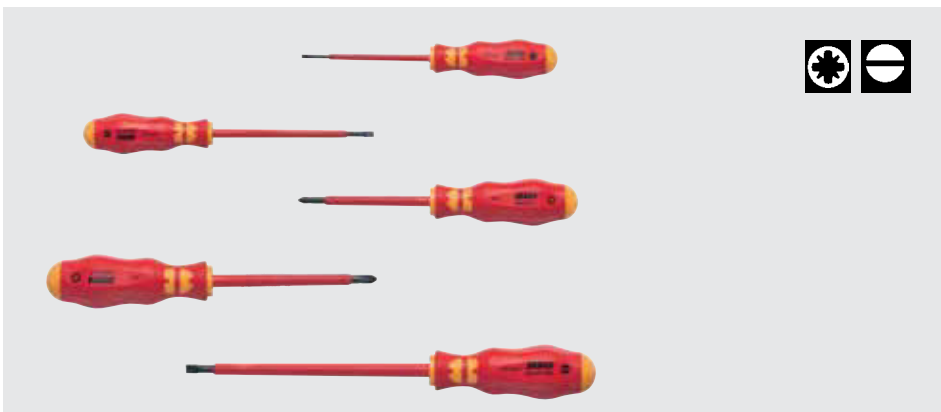
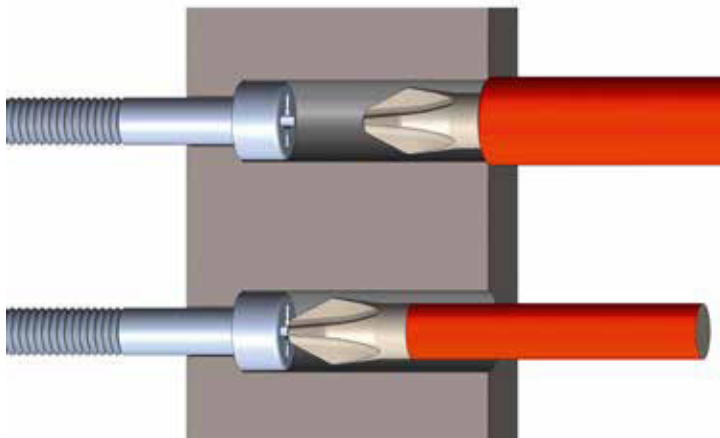

VDE Screwdriver Set, PZ & Slotted - 5pcs

Contents:

Slotted; 0.4 x 2.5 x 80, 0.8 x 4.0 x 100, 1.2 x 6.5 x 150, PZ 1 and PZ 2

Art. No. 0613 963 35

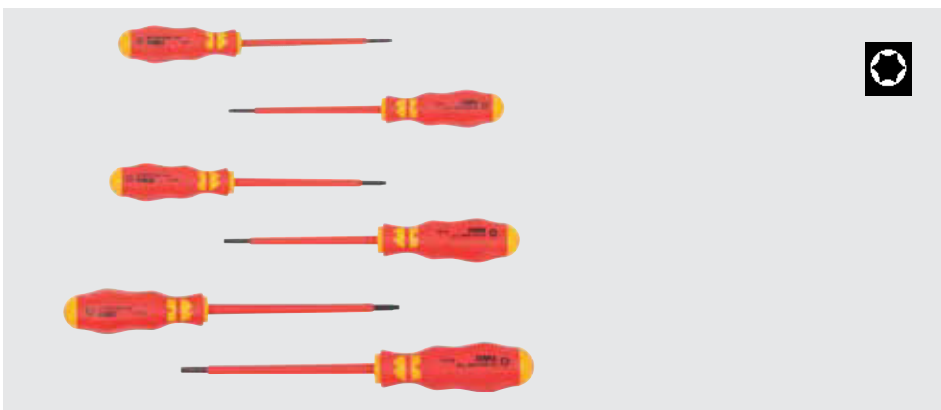

VDE Screwdriver Set, TX - 6pcs

Contents:

TX8, TX9, TX10, TX15, TX20 and TX25

Art. No. 0613 962 35



T-Handle Screwdriver Set, Ex Hex - 5pcs

Contents:
6, 7, 8, 10 and 13mm

Art. No. 0613 912 05

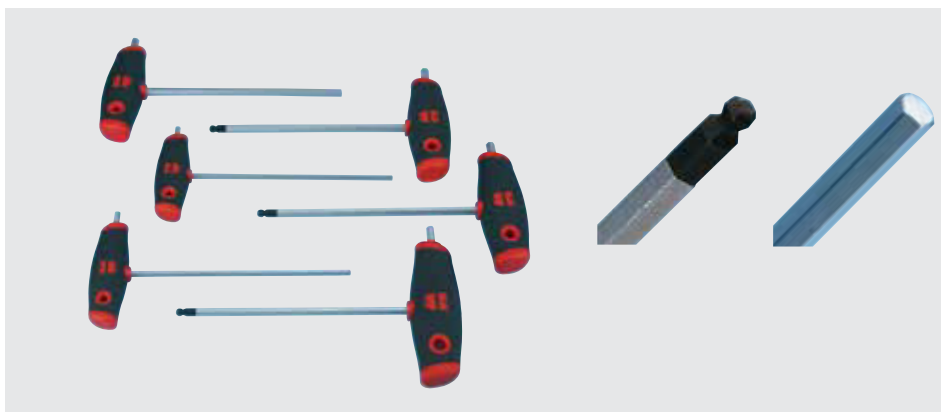
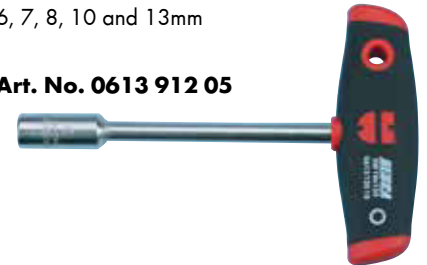

T-Handle Screwdriver Set, Hex - 6pcs

Contents:
2.5, 3, 4, 5*, 6*, and 8mm*
* with ball head

Art. No. 0613 913 06

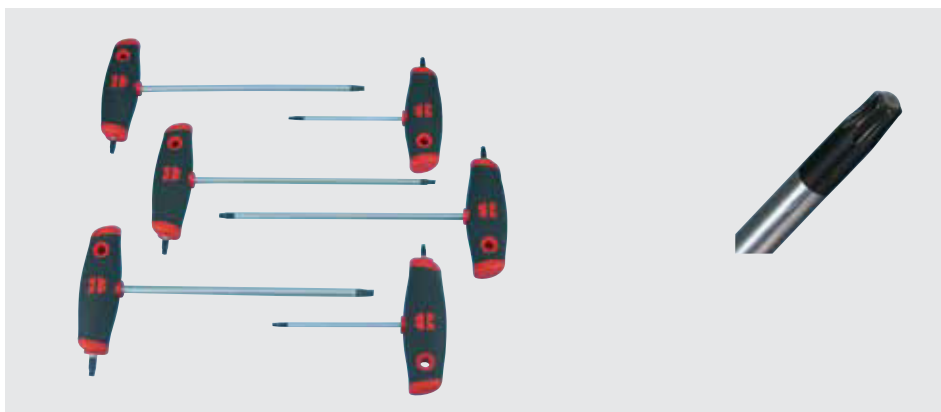

T-Handle Screwdriver Set, TX - 6pcs

Contents:
TX10, TX15, TX20, TX25, TX30 and TX40

Art. No. 0613 914 06

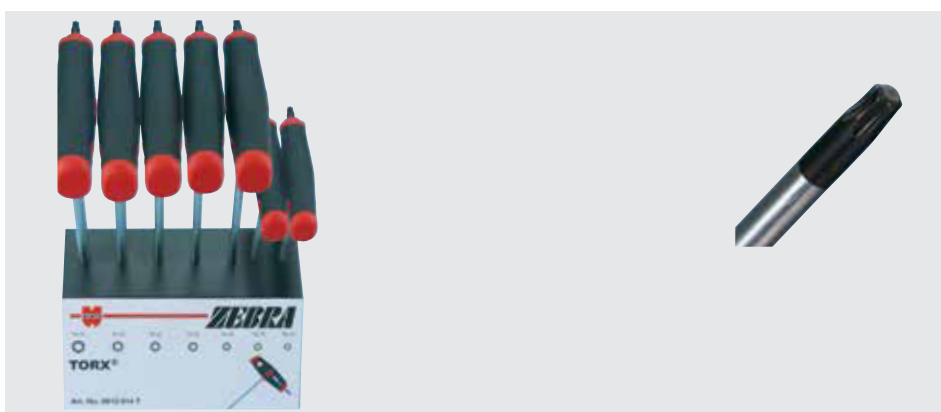

T-Handle Screwdriver Set, TX - 7pcs

Contents:
Holder Rack
TX10, TX15, TX20, TX25, TX30, TX40 and TX45

Art. No. 0613 914 7

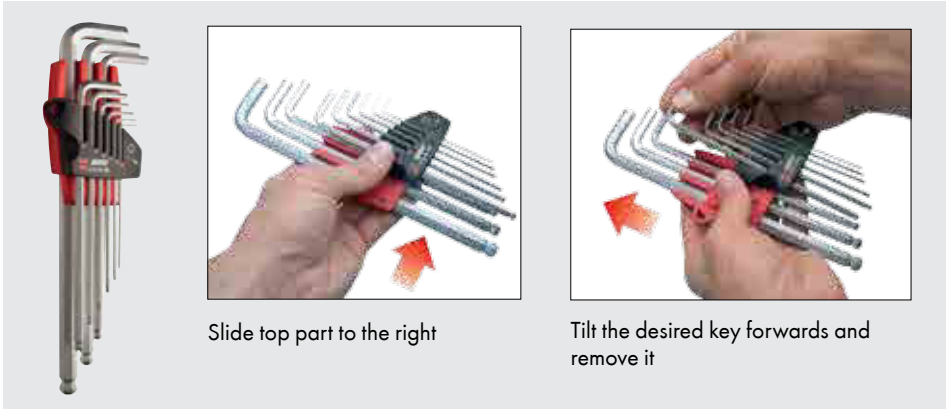

Slide top part to the right

Tilt the desired key forwards and remove it

Allen Key Set, Ball Head - 9pcs

Contents:
1,5; 2; 2,5; 3; 4; 5; 6; 8; 10mm

Art. No. 0715 40 100

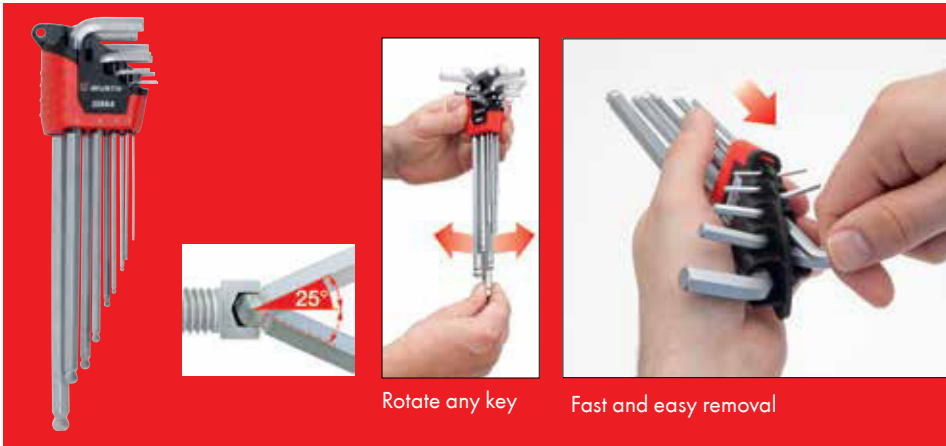

Rotate any key

Fast and easy removal

Allen Key Set, Ball Head - 9pcs

Contents:
1,5; 2; 2,5; 3; 4; 5; 6; 8; 10mm

Art. No. 0715 40 50



Allen Key Set, with Retaining Ring - 9pcs

Contents:
1,5; 2; 2,5; 3; 4; 5; 6; 8; 10mm

Art. No. 0715 50 100



Torx Key Set - 13pcs

Contents:
TX5, TX6, TX7, TX8, TX9, TX10, TX15, TX20,
TX25, TX27, TX30, TX40 and TX45

Art. No. 0715 39 10

BIT SETS



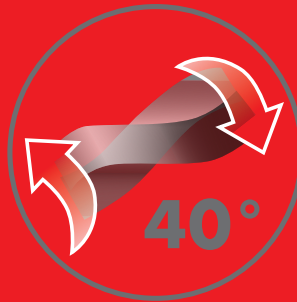

Impact Flex Bit Box

- High performance bit for difficult screw applications, ideally suited for use with impact screwdrivers
- The longer torsion zone enables a twisting angle of more than 40° and thus absorbs the peak loads which arrive
- Upto twice the service life of other high-performance impact bits on the market
- Up to three times the service life in comparison to regular standard bits.

Contents:

PH2, PZ2, TX20 (x2, TX25, TX30, TX40 and a Universal Bit Holder

Art. No. 0614 250 115

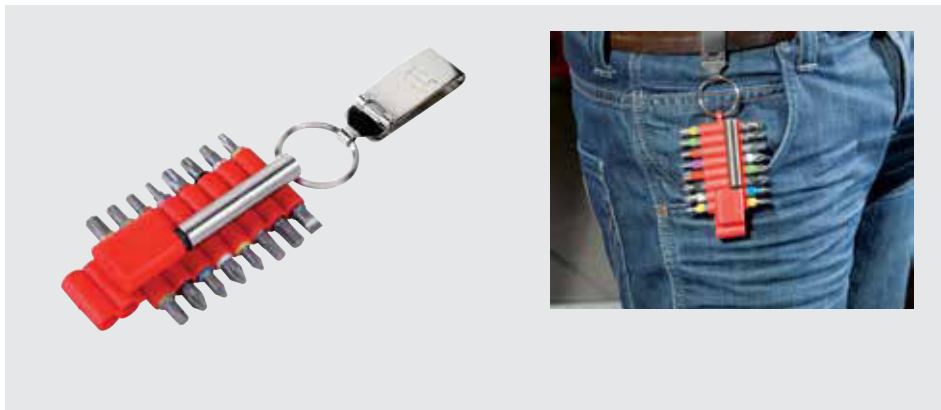

Bit Set, Mixed - 17pcs

Contents:

1x each PH1, PH2, PZ1, PZ2, SZ 0.8 x 5.5, 4 mm Allen Head, 5 mm Allen Head, TX15, TX20, TX25, TX30, AW10, AW20, AW25, AW30 and Universal Holder

Art. No. 0614 203



Bit Set, Mixed - 31pcs

Contents:

31 Bits; AW10, 20(x2 and 30 Slotted; 0.6x4.5, 0.8x5.5 and 1.2x6.5
 PZ; 1(x2 and 2(x3
 PH; 1(x2 and 2(x2
 Hex; 3, 4 and 5mm
 TX; 10(x2, 15, 20(x2, 25(x2, 30(x2 and 40
 Universal Bit Holder

Art. No. 0614 250 031

Bit Set, Mixed - 105pcs

Contents:

1/4" Bit Adaptor and Magnetic Bit Holder

25mm Bits;

AW; 10, 20, 25, 30 and 40

Slotted; 0.6 x 4.5, 0.8 x 5.5, 1.2 x 6.5 and 1.2 x 8

PH; 0, 1, 2 and 3 PZ; 0, 1, 2 and 3

TX; 8, 10, 15, 20, 25, 27, 30, 40 and 45

Allen Head; 2, 2.5, 3, 4, 5, 6, 1/4" and 7mm

TX with Hole; 8, 10, 15, 20, 25, 27, 30, 40 and 45

Claw Wrench; 4, 6, 8 and 10

Three Wing; 1, 2, 3 and 4

Torq; 6, 8 and 10

Spline; M4, 6, 8 and 10

Allen Head Inches; 1/8, 9/64, 5/32 and 3/16"

Ribe; M5, 6, 7 and 8

Allen Head with Hole; 2, 2.5, 3, 4, 5, 6 and 7mm

Square; 1, 2, 3 and 4

Clutch; 3/32, 1/8 and 5/32"

70mm Bits;

Slotted; 0.8 x 5mm, PH; 1 and 2

Three Wing; 1 and 2

Claw Wrench; 6 and 8

TX with Hole; 10, 15, 20, 25 and 30

Five Star with Hole; 20, 25 and 30

Art. No. 0614 250 300



Torx Socket & Bit Assortment, 10mm - 30pcs

Contents:

Adaptor for 3/8" Ratchet and Adaptor for 1/2" Ratchet

16 Bits, 10mm;

Torx with Hole, 30mm; 20, 25, 27, 30, 40, 50 and 55

Torx, 75mm; 20, 25, 27, 30, 40, 50 and 55

5 1/4" Sockets, External Torx; E5, 6, 7, 8 and 10

7 1/2" Sockets, External Torx; E11, 12, 14, 16, 18, 20 and 24

Art. No. 0965 12 300





Bit Assortment, 10mm - 38pcs

Contents:

10mm Bit Ratchet,
 Adapter for 1/2" Ratchet, 37 mm,
 TX bits with bore, 30 mm: TX 20, 25, 27, 30, 40, 45, 50, 55.
 TX bits, 75 mm: TX 20, 25, 27, 30, 40, 45, 50, 55.
 TX bits, 120 mm: TX 40, 45, 50.
 Allen Head bit, 30 mm: 5, 6, 7, 8, 10, 12 mm.
 Spline multipoint bit, 30 mm: M 5, 6, 8, 10, 12.
 Spline multipoint bit, 75 mm: M 6, 8, 10, 12.
 PH 2, 30 mm and PH 3, 30 mm.

Art. No. 0965 12 371



Bit Assortment, 10mm - 47pcs

Contents:

Adaptor for 3/8" Ratchet and Adaptor for 1/2" Ratchet
 45 Bits, 10mm;
 Torx with Hole, 30mm; 20, 25, 27, 30, 40, 50 and 55
 Torx, 75mm; 20, 25, 27, 30, 40, 50 and 55
 Allen Head, 30mm; 5, 6, 7, 8 and 10mm
 Spline, 30mm; M5, 6, 8, 10 and 12
 Spline, 75mm; M6, 8, 10 and 12
 Ribe, 30mm; R15, 6, 7, 8, 9, 10, 12, 13 and 14
 Ribe, 75mm; R15, 6, 8 and 10
 PH, 300mm; 1 and 2

Art. No. 0965 12 470



PLIER SETS





Pliers Set, 3pcs

Contents:
Combination Pliers 180mm
Water Pump Pliers 250mm
Power Side Cutters 160mm

Art. No. 0714 01 564



Pliers Set - 4pcs

Contents:
Combination Pliers 180mm
Wire Stripping Pliers 160mm
Snipe Nose Pliers 210mm
Power Side Cutters 160mm

Art. No. 0714 01 560



Pliers Set - 4pcs

Contents:
Combination Pliers 180mm
Water Pump Pliers 250mm
Snipe Nose Pliers 210mm
Power Side Cutters 160mm

Art. No. 00714 01 565



VDE Pliers Set - 3pcs

Contents:
Combination Pliers 180mm
Cable Shears 210mm
Side Cutters 160mm

Art. No. 0714 01 569



VDE Pliers Set - 4pcs

Content:
Combination Pliers 180mm
Wire Stripping Pliers 160mm
Snipe Nose Pliers 210mm
Side Cutters 160mm

Art. No. 0714 01 580



VDE Pliers Set - 4pcs

Contents:
Combination Pliers 180mm
Cable Shears 160mm
Snipe Nose Pliers 210mm
Side Cutters 160mm

Art. No. 0714 01 581



VDE Pliers & Screwdriver Sets - 8pcs

Contents:
Wire Stripping Pliers 160mm
Side Cutters 160 mm
Snipe Nose Pliers 210 mm
Slotted Screwdrivers; 0.4 x 55 x 2.5mm, 0.8 x 55 x 4.0mm, 1.2 x 55 x 6.5mm,
PH 1, PH 2

Art. No. 0714 01 582





Pliers Set - 3pcs

Contents:
Snipe Nose Pliers 200mm
Side Cutters 180mm
Combination Pliers 180mm

Art. No. 0715 01 561

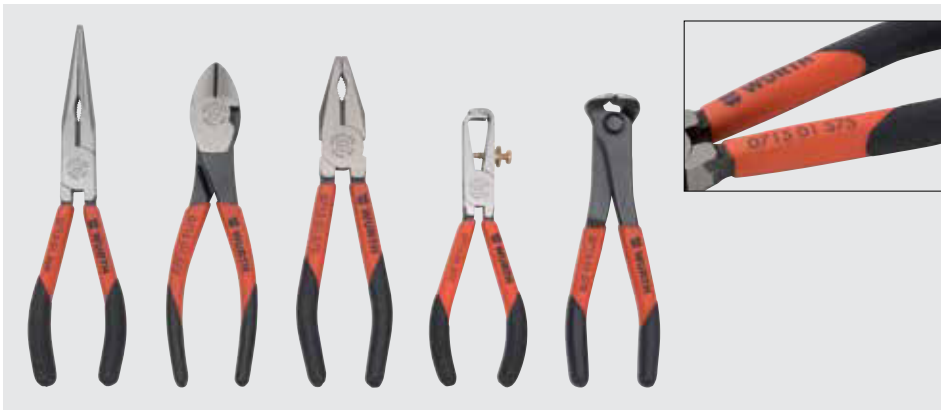

Pliers Set - 5pcs

Contents:
Snipe Nose Pliers 200mm
Side Cutters 180mm
Combination Pliers 180mm
Wire Stripping Pliers 160mm
End Cutting Nippers 160mm

Art. No. 0715 01 560

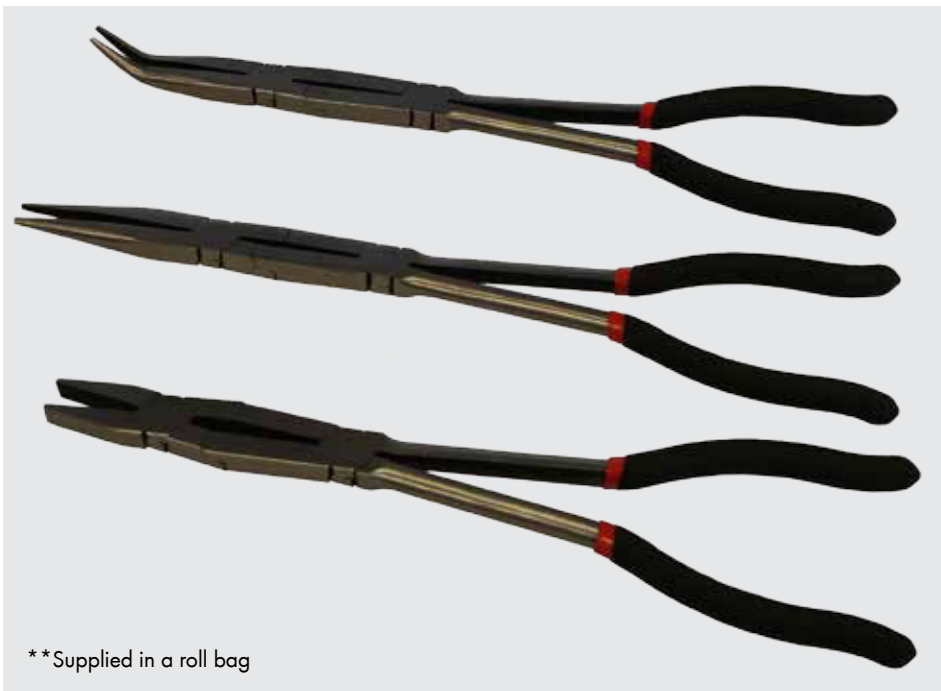

Extra Long, Double Jointed Pliers Set - 3pcs

Contents:
Long Needle Nose 330mm
Long Needle Nose 45deg 330mm
Flat Nose Pliers 330mm

Art. No. 0715 02 600

**Supplied in a roll bag



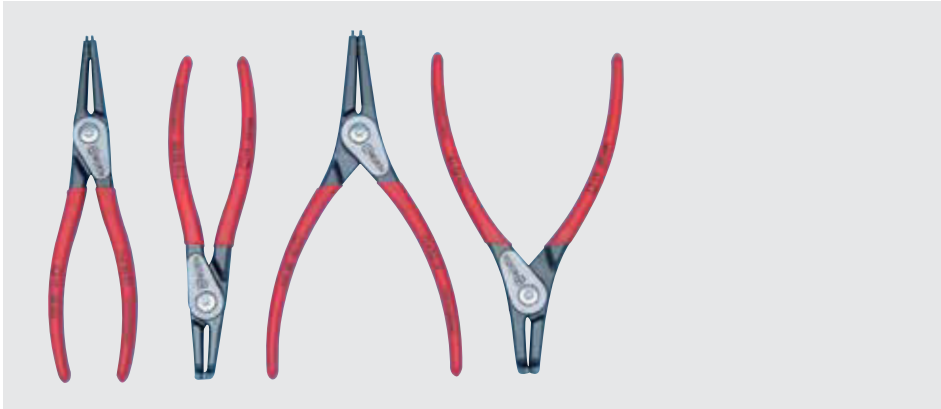

Circlip Pliers Set - 4pcs

Content:
Internal Straight 19- 60mm
External Straight 19- 60mm
Internal Bent 19- 60mm
External Bent 19- 60mm

Art. No. 0714 02 30

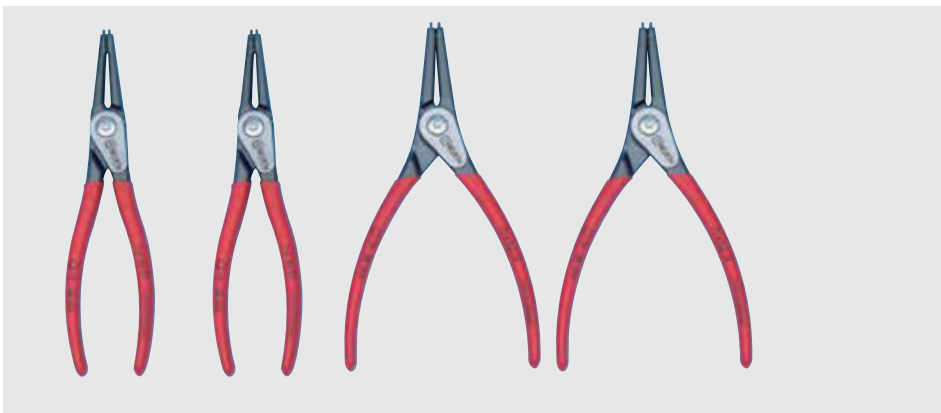

Circlip Pliers Set - 4pcs

Content:
Internal Straight 12- 25mm
External Straight 10- 25mm
Internal Straight 19- 60mm
External Straight 19- 60mm

Art. No. 0714 02 31



Circlip Pliers Set - 4pcs

Content:
Internal Bent 12- 25mm
External Bent 10- 25mm
Internal Bent 19- 60mm
External Bent 19- 60mm

Art. No. 0714 02 32





Locking Pliers Set - 3pcs

Content:
6" Needle Nose
10" Curve Jaw with Wire Cutter
7" Straight Jaw

Art. No. 0714 09 006



Locking Pliers Set - 4pcs

Contents:
6" Needle Nose
5" Curve Jaw with Wire Cutter
10" Curve Jaw with Wire Cutter
7" Straight Jaw

Art. No. 0714 09 007





Locking Pliers Set - 14pcs

Contents:

Locking Pliers-Needle Jaw-120mm
Locking Pliers-Needle Jaw-150mm
Locking Pliers-Needle Jaw-230mm
Locking Pliers-Curved Jaw-130mm
Locking Pliers-Curved Jaw-180mm
Locking Pliers-Curved Jaw-250mm
Locking Pliers-Straight Jaw-180mm

Locking Pliers-Straight Jaw-250mm
Locking Pliers-Sheet Metal-200mm
Locking Pliers-Welding-230mm
Locking Pliers-C-Clamp-150mm
Locking Pliers-C-Clamp-280mm
Locking Pliers-C-Clamp-455mm
Locking Pliers-C-Clamp-Swivel-280mm

Art. No. 0714 09 008

Comes complete with shadow board

HAND TOOL RANGE

2019/2020

Wuerth Industrial Services Malaysia Sdn. Bhd.

Lot 806, Jalan Subang 5
Taman Perindustrian Subang
47600 Subang Jaya, Selangor
Phone +60 3 8021 0200
info@wuerth-industry.my
www.wuerth.my

Reproduction only with permission.

MWC - DNP/SF - ZPPD - 150 - 02/19

Printed on environmentally friendly paper.

We reserve the right to make any changes we deem necessary to improve the quality of the product, even without prior announcement or notification. Illustrations may be example illustrations that may differ in appearance from the goods supplied. Errors excepted. We accept no liability for any printing errors. Our general terms and conditions apply.

