

Wuerth Industrial Services Malaysia

PRODUCTS FOR REFINERY INDUSTRY

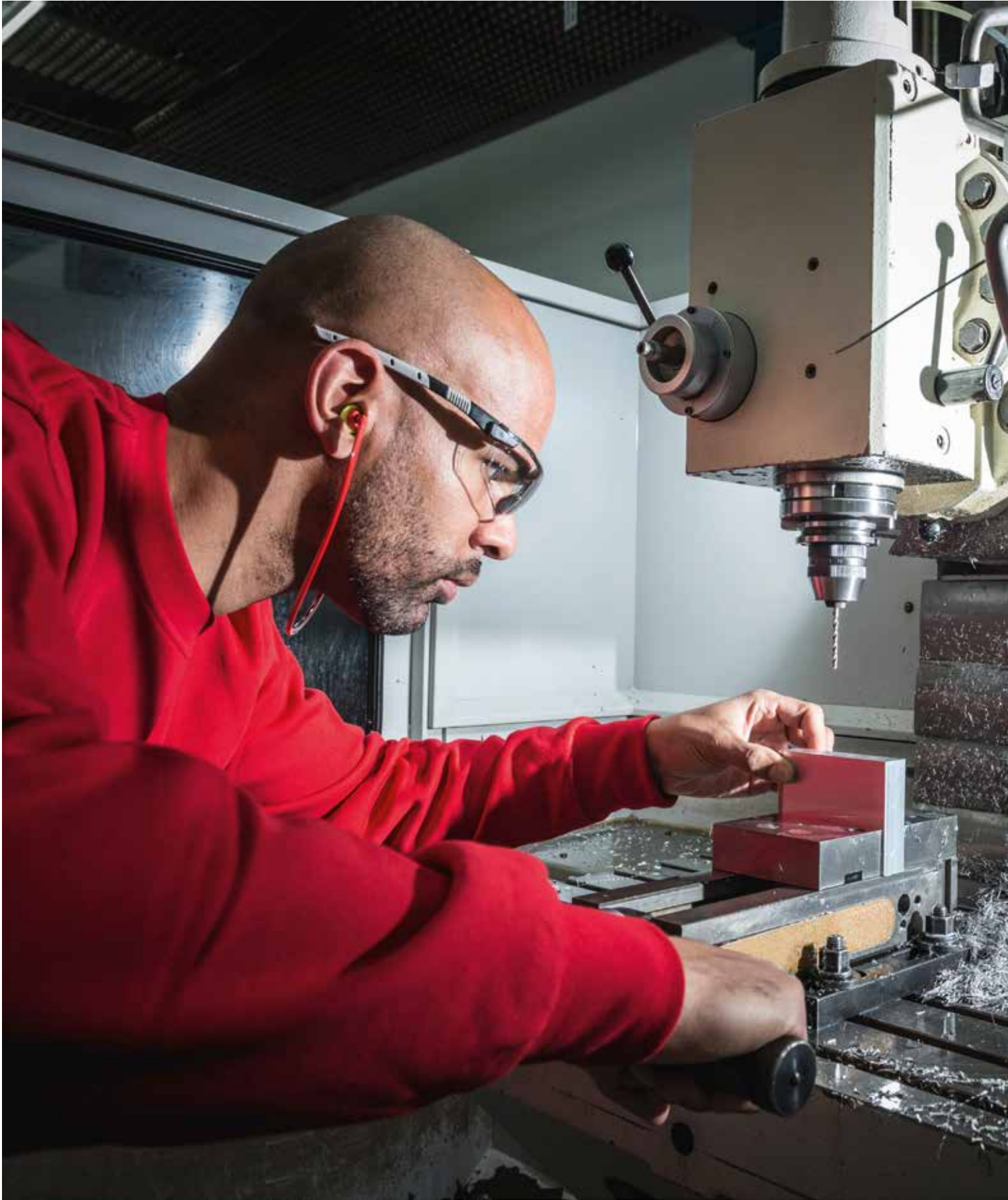





CONTENTS

ORSY® SYSTEM CASE 4 - 5

ENGINEERING & CONSTRUCTION

Work preparation	6 - 11
Welding	12 - 13
Machining surface treatment	14 - 21
Assembly of mechanical component	22 - 25
Assembly of electrical parts	26 - 29
Finalizing shipping	30 - 33

FASTENERS 34 - 35

INSTALLATION

Deassembly and cleaning	36 - 49
Assembly installation of new parts	50 - 55

SERVICES 58 - 59

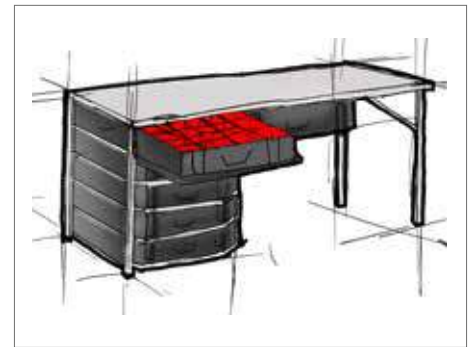
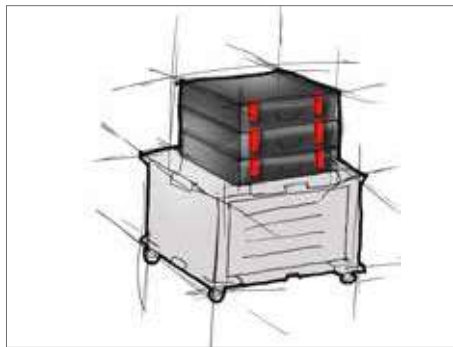

The coupling. It's the building block for growth.

A case seldom comes alone. The System Case never does.

Lots of space inside, lots of functions outside.

EVERYTHING IN PERFECT ORDER.

The new ORSY® System Cases are now available.

With ORSY, we are shaping the organizational principle of the future for you: Everything fits together, and all the parts fit inside one another. ORSY means order with a system. It's an idea, a principle. You could even say it's a philosophy. It's a totally new type of organization with a broad range of uses. It's a unique modular unit with a large number of connected components. All made to measure. Würth is reinventing ORSY and this journey begins with the System Case. Your organizational tool for day-to-day work developed by Würth, for you.

It goes anywhere, and everything fits inside.

Get in on the organizational system of the future, and let it boost your time, money and expertise. The ORSY system is practical, versatile and ideal for day-to-day use. Get started in the world of ORSY now! Innovation always means opportunity. Let this system help grow your business. We're right there with you - Close, closer, Würth.

The grid size ensures that all the elements of the ORSY system world are coordinated and compatible with one another.

In this world, everything fits together, and everything has its place: small parts, tools, machines and lots more.



The material? Tough as nails.



Everything under control and locked up tight.



Our product assortment policy: Always be flexible.

ENGINEERING & CONSTRUCTION

Work preparation - Welding - Machining surface treatment - Assembly of mechanical component - Assembly of electrical parts - Finalizing shipping

Ear plugs

Art. no. 0899 300 33



Ear defenders pocket

Art. no. 0899 300 230



Ear plug band x-300

Art. no. 0899 300 339



Safety glasses Cetus

Art. no. 0899 102 320



Safety glasses Cepheus

Art. no. 0899 102 250

INSTALLATION

Deassembly and cleaning – Assembly installation of new parts



Disposable nitrile glove
Art. no. 0899 470 03



Assembly glove Economy
Art. no. 0899 400 61...

Folding mask FM 3000 FFP2 NR D
Art. no. 0899 110 522



**Cut protection glove CUT 3/200
with Kevlar**
Art. no. 0899 400 4...

Cup-shaped mask CM 3000 FFP1 NR D
Art. no. 0899 110 500



ENGINEERING & CONSTRUCTION

Work preparation - Welding - Machining surface treatment - Assembly of mechanical component - Assembly of electrical parts - Finalizing shipping

Basic overalls

Art. no. M00503...



Basic dungarees

Art. no. M00414...



Basic trousers

Art. no. M0031...



Basic jacket

Art. no. M00114...



INSTALLATION

Deassembly and cleaning – Assembly installation of new parts



S1P low-cut safety shoes
Art. no. M0160260...



**S2 FLEXITEC® ESD
safety boots**
Art. no. M0210210...

S1P Safety boots
Art. no. M4240250...



2-component cutter knife
Art. no. 0715 66 27...



Pocket tape measure
Art. no. 0714 645 66



ENGINEERING & CONSTRUCTION

Work preparation - Welding - Machining surface treatment - Assembly of mechanical component - Assembly of electrical parts - Finalizing shipping

LED work lamp
Art. no. 0981 180 0...



Vernier calliper with torque fixing
Art. no. 071 576 01



Workshop trolley Toolsystem Compact 7
Art. no. 0962 612 04...



Trolley Type FW 3
Art. no. 0957 342 03...



INSTALLATION

Deassembly and cleaning – Assembly installation of new parts

Light metal spirit level
Art. no. 0714 644 2...



ORSY® BULL top loader box
Art. no. 0962 330 002



Rolls of Ecoline cleaning paper
Art. no. 0899 800 ...



Hand cleaner Basic
Art. no. 0893 900 015



Industry cleaner
Art. no. 0893 14...



Workshop cleaner BMF
Art. no. 0893 118...



Eco Line universal cleaner
Art. no. 0890 290 002



ENGINEERING & CONSTRUCTION

Work preparation - **Welding** - Machining surface treatment - Assembly of mechanical component - Assembly of electrical parts - Finalizing shipping

Automatic welding helmet WSH II 9-13
Art. no. 0984 670 100



Welding cap WSC 9-12
Art. no. 0984 700 300



Welding goggles FORNAX®plus
Art. no. 0984 502 250



CEPHEUS® welding goggles
Art. no. 0984 502 150



Visor
Art. no. 071382 100



Protective lens up to protection level 14
Art. no. 0984 500 ...

INSTALLATION

Deassembly and cleaning – Assembly installation of new parts



Leather welding glove
Art. no. 0984 314 ...



Welding spray perfect
Art. no. 0893 102 100



Leather glove
Art. no. 0899 400 251

S3 Welder safety boots
Art. no. M0220620...



ENGINEERING & CONSTRUCTION

Work preparation - Welding - Machining surface treatment - Assembly of mechanical component - Assembly of electrical parts - Finalizing shipping

Safety goggles LIBRA
Art. no. 0899 102 275



Full-vision goggles Andromeda®
Art. no. 0899 102 110



Mechanics' glove
Art. no. 0899 400 5...



Battery-powered screw driller BS 18-A Power
Art. no. 0700 665 0...



Protective glove Protect
Art. no. 0899 400 132



Ear defenders
Art. no. 0899 300 280



Split leather gloves
Art. no. 0899 400 251



INSTALLATION

Deassembly and cleaning – Assembly installation of new parts

Angle grinder EWS 12-125 Solid
Art. no. 5707 040 0



Two-hand angle grinder EWS 24-230
Art. no. 0702 446 10



ENGINEERING & CONSTRUCTION

Work preparation - Welding - **Machining surface treatment** - Assembly of mechanical component - Assembly of electrical parts - Finalizing shipping

Battery-powered angle grinder EWS 18-A

Art. no. 0700 235 01



Battery-powered angle grinder EWS 28-A

Art. no. 0700 237 03



INSTALLATION

Deassembly and cleaning – Assembly installation of new parts

Speed cutting disc for steel
Art. no. 0664 10 ...



Speed cutting disc for non-ferrous metals/aluminium
Art. no. 0664 12. ...



Longlife rough grinding disc for steel
Art. no. 0670 16 ...



Longlife rough grinding disc for aluminium/non-ferrous metals
Art. no. 0670 171 ...



Flap disc
Art. no. 0578 480 524



Vulcanised fibre disc
Art. no. 0580 712 536



Support plate, vulcanised fibre disc
Art. no. 0586 580 225



Sanding fleece roll
Art. no. 0585 805 280



ENGINEERING & CONSTRUCTION

Work preparation - Welding - Machining surface treatment - Assembly of mechanical component - Assembly of electrical parts - Finalizing shipping

Cutter pin
Art. no. 0616 001 011



Spiral drill bit, metal
Art. no. 0618 300 800



Twist drill, metal
Art. no. 0626 040 100



Stepped twist drill bit TiAlN
Art. no. 0694 423 639



Twist drill, metal
Art. no. 0624 000 050



Machine screw tap, through holes
Art. no. 0653 100 03



Machine screw tap, blind holes
Art. no. 0655 010 003



**Cylinder saw, HSS bi-metal
Longlife & Speed HSSCO8**
Art. no. 0632 900 ...

Cylinder saw HSS bi-metal
Art. no. 0632 90 0



Conical countersink, machinery, HSS
Art. no. 0694 020 06



**Quick-change adapter for bi-metal
cylinder saws**
Art. no. 0632 900 000



INSTALLATION

Deassembly and cleaning – Assembly installation of new parts

Cutting and drilling oil CUT+COOL

Art. no. 0893 050 004



Cutting and drilling oil CUT+COOL Perfect

Art. no. 0893 050 008



Drilling and cutting oil CUT+COOL Eco

Art. no. 0893 050 011



Cooling lubricant CUT+COOL Ultra

Art. no. 0893 050 031



Cooling lubricant CUT+COOL Ultra HD

Art. no. 0893 050 036



Maintenance oil Multi

Art. no. 0893 055 40



ENGINEERING & CONSTRUCTION

Work preparation - Welding - **Machining surface treatment** - Assembly of mechanical component - Assembly of electrical parts - Finalizing shipping

Adhesive lubricant HHS 5000
Art. no. 0893 106 3



Diluting, lacquer
Art. no. 0823 440 6



Spray can attachment (without can)
Art. no. 0891 090



Adhesive lubricant HHS® Grease
Art. no. 0893 106 7



Roller dispenser, cleaning paper
Art. no. 0899 800 606



Cleaning paper Ecoline on rolls
Art. no. 0899 800 823



INSTALLATION

Deassembly and cleaning – Assembly installation of new parts

Zinc spray
Art. no. 0893 114 114



Primer
Art. no. 0893 210 1



Remover of silicone
Art. no. 0893 222 600



Liquid Metal FE1
Art. no. 0893 449



Masking tape, interior heat-resistant
Art. no. 0992 625

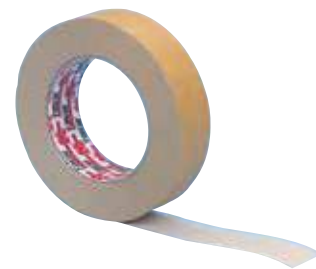

Protective glove, disposable
Art. no. 0899 470 ...



Colour card
Art. no. 0705 800 010



ENGINEERING & CONSTRUCTION

Work preparation - Welding - Machining surface treatment - **Assembly of mechanical component** - Assembly of electrical parts - Finalizing shipping

Screwdriver set, hexagon blade, PH/slotted, 5 pcs
Art. no. 0613 932 25



Safety bit assortment
Art. no. 0614 250 30



Combination wrench assortment
Art. no. 0713 309 50



Circlip pliers set/kit
Art. no. 0714 02 30



Parallel pin driver
Art. no. 0714 63 255



Fitters' hammer
Art. no. 0714 732 405



Soft face hammer
Art. no. 0715 72 ...



INSTALLATION

Deassembly and cleaning – Assembly installation of new parts

Adhesive tape, textile-reinforced
Art. no. 0874 100 200

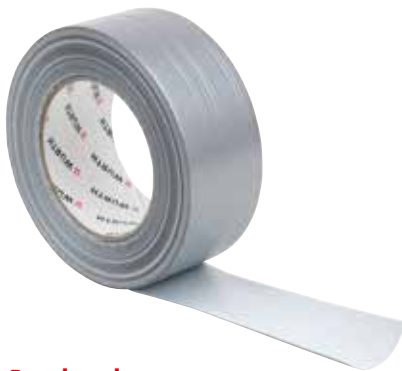

Bond seal
Art. no. 0890 100 3



Superglue
Art. no. 0893 09

Chemical screw fixing
Art. no. 0893 243 050

ENGINEERING & CONSTRUCTION

Work preparation - Welding - Machining surface treatment - **Assembly of mechanical component** - Assembly of electrical parts - Finalizing shipping

Assembly paste
Art. no. 0893 123



Circlip assortment
Art. no. 5964 043 800



Securing tape, double-sided
Art. no. 0894 909 005

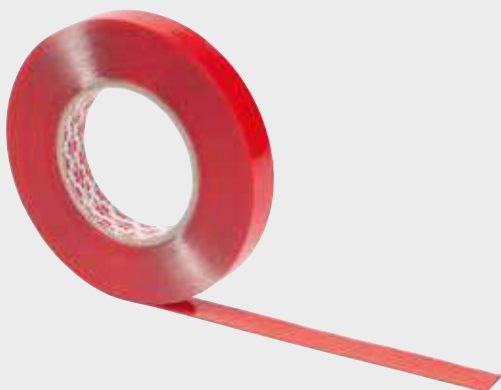

Protective glove Craftsman
Art. no. 0899 400 653



INSTALLATION

Deassembly and cleaning – Assembly installation of new parts

Pass-through socket wrench assortment

Art. no. 0965 13 036



Socket wrench 1/4 - 1/2 inch assortment

Art. no. 0965 17 56



Masking crepe tape

Art. no. 0992 005 0



Allen key set

Art. no. 0715 40 100



ENGINEERING & CONSTRUCTION

Work preparation - Welding - Machining surface treatment - Assembly of mechanical component - **Assembly of electrical parts** - Finalizing shipping

VDE pliers assortment, IEC 60900

Art. no. 0714 01 581

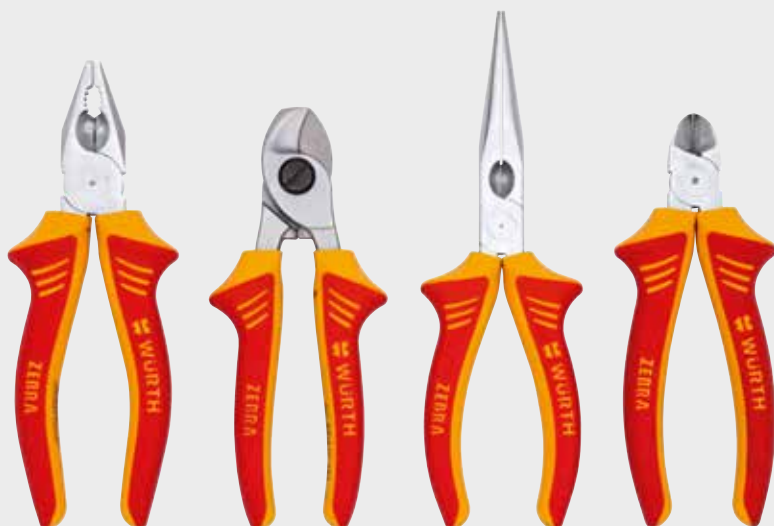

VDE combination pliers DIN ISO 5746 IEC 60900

Art. no. 0714 01 57...



Adhesive mount, cable tie

Art. no. 0502 648



Wire end ferrule, insulated set

Art. no. 0557 300



Drilling screw hexagon head flanged

Art. no. 0214 006 16



Coloured cable tie with plastic tongue closure

Art. no. 0502 4...



Cable tie, plastic latch

Art. no. 0502 151



Butt connector, insulated

Art. no. 0558 925 1



INSTALLATION

Deassembly and cleaning – Assembly installation of new parts



Push connector, insulated
Art. no. 0558 960



Screwdriver, VDE assortment
Art. no. 0613 963 250

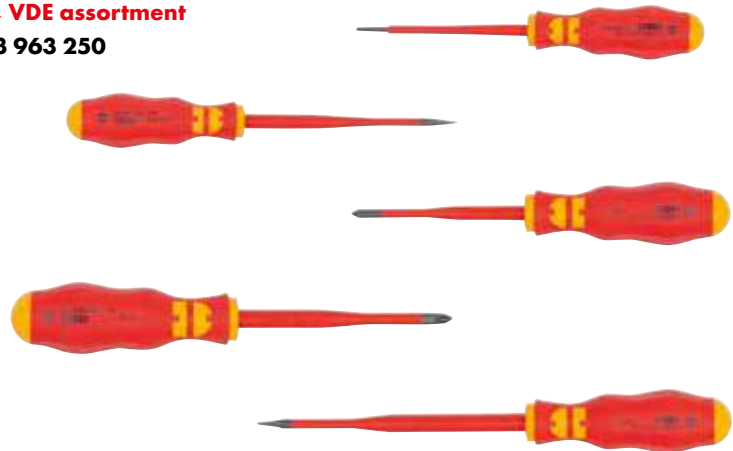

Stepped drill bit, spiral
Art. no. 0694 423 639



Side cutters VDE
Art. no. 0714 01 572



ENGINEERING & CONSTRUCTION

Work preparation - Welding - Machining surface treatment - Assembly of mechanical component - **Assembly of electrical parts** - Finalizing shipping



Crimping pliers
Art. no. 0714 107 100



Wire stripping pliers, self-adjusting
Art. no. 0714 108 10

INSTALLATION

Deassembly and cleaning – Assembly installation of new parts

Thin-walled heat-shrink hose assortment
Art. no. 5964 077 100



Heat-shrink hose assortment
Art. no. 0964 771 0



Insulating tape, electric
Art. no. 0985 101



Cable gland, metric
Art. no. 0967 705 012



Two-pin voltage tester ProII LED
Art. no. 0715 53 165



ENGINEERING & CONSTRUCTION

Work preparation - Welding - Machining surface treatment - Assembly of mechanical component - Assembly of electrical parts - Finalizing shipping

Long-life grease
Art. no. 0890 402



Hand-lever grease gun
Art. no. 0986 00



Remover of label
Art. no. 0893 140



Silicone spray, universal
Art. no. 0893 221



Multi-purpose grease
Art. no. 0893 870 1



INSTALLATION

Deassembly and cleaning – Assembly installation of new parts

Cleaning paper

Art. no. 0899 800 773



Packing tape

Art. no. 0985 050

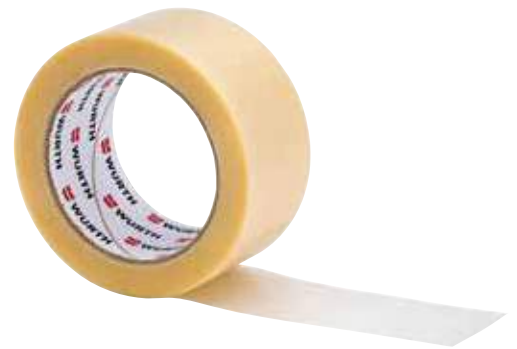

Spannfix strapping system

Art. no. 0899 713 000



Dispenser for packing tape

Art. no. 0985 052 005



ENGINEERING & CONSTRUCTION

Work preparation - Welding - Machining surface treatment - Assembly of mechanical component - Assembly of electrical parts - Finalizing shipping



Load-securing net
Art. no. 0963 80 316

Ratchet lashing belt for inner lashing
Art. no. 0713 923 0



Ratchet lashing belt, two part
Art. no. 0713 91...

Ratchet lashing belt, two-part, S-hook
Art. no. 0713 92 13



Ratchet lashing belt, one-part
Art. no. 0713 92...



INSTALLATION

Deassembly and cleaning – Assembly installation of new parts



FASTENERS

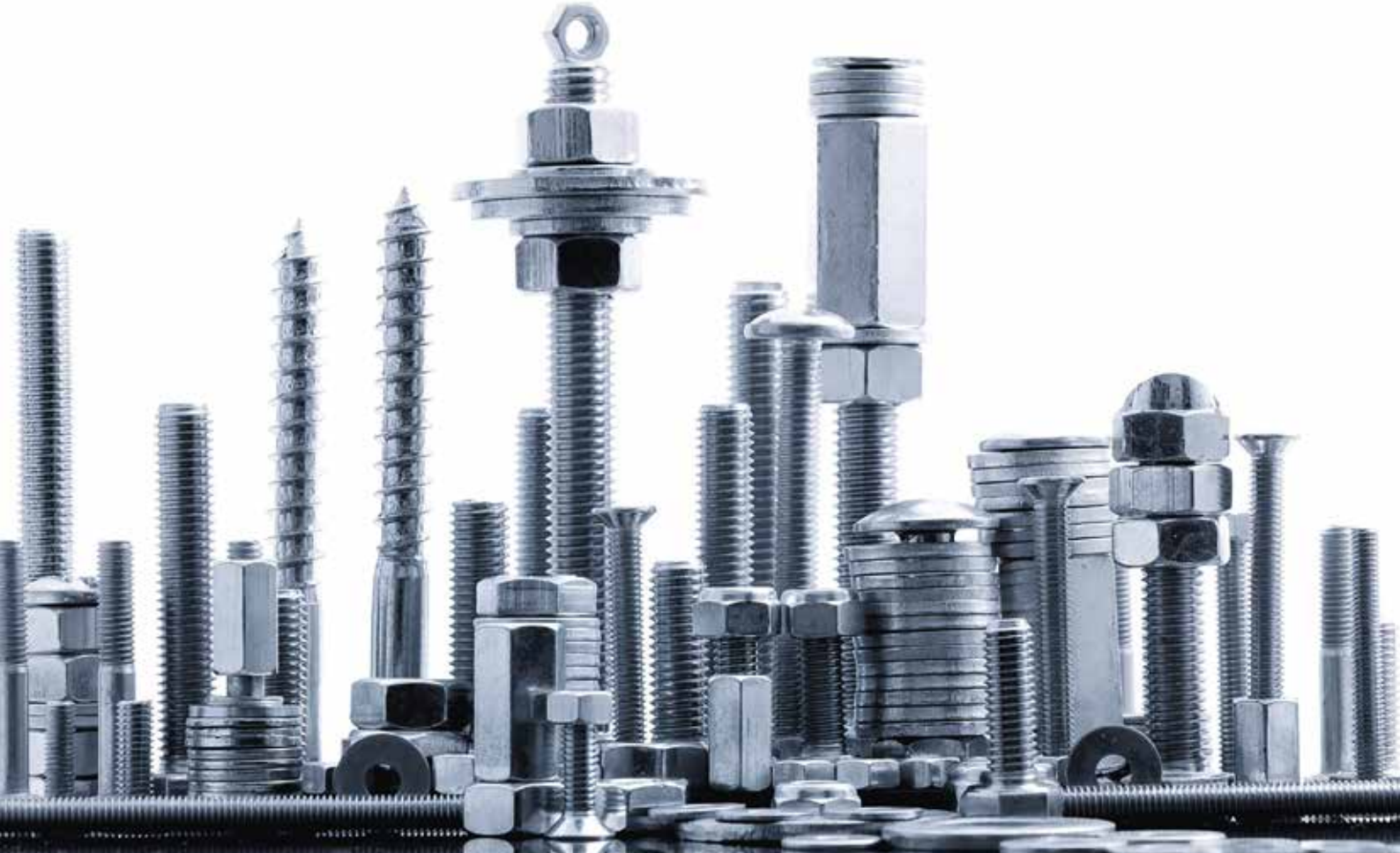

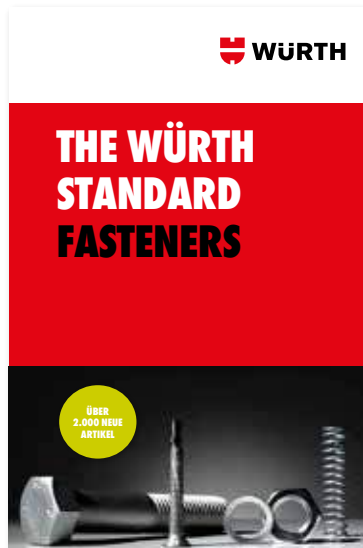
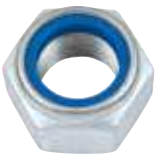

Always at your side. For more than 70 years.

Würth has always been your reliable partner in all matters related to screws and bolts, nuts, washers and standard parts in general. Now, we have expanded our product range even further in this new issue of our catalog, so we can make sure we will remain what we have always been: the pioneering partner for standard parts.

Browse our catalog at

www.wuerth.my/dino-online

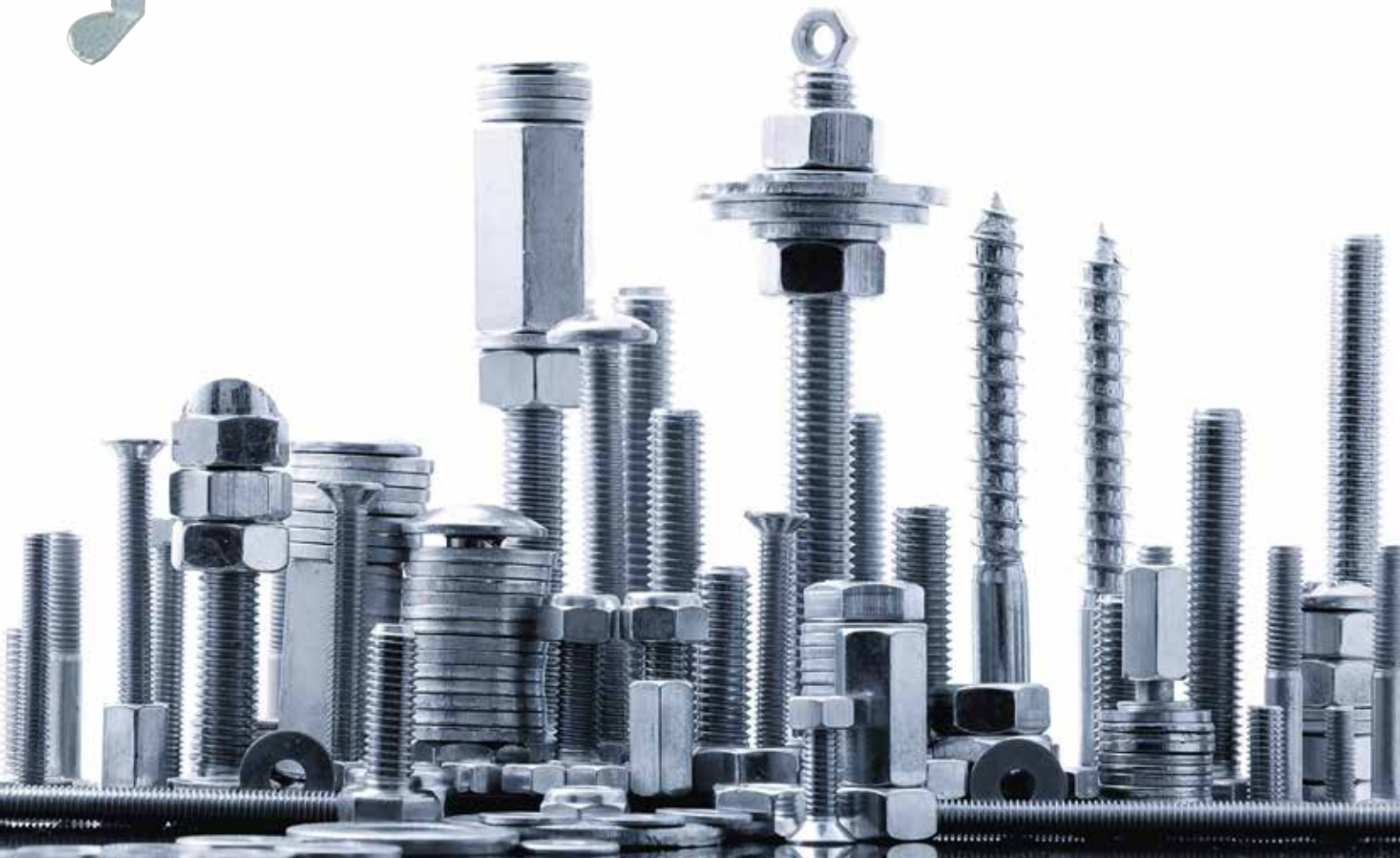

PREFABRICATION PHASE (INHOUSE)

Work preparation - Welding - Machining surface treatment - Assembly of mechanical component - Assembly of electrical parts - Finalizing shipping

Hard hat SH 2000-S Pro (1)
Art. no. 0899 200 235

Working-at-height helmet (2)
Art. no. 0899 200 290



Ear defenders for helm mounting
Art. no. 0899 300 240



Cut protection glove CUT 3/100 with Dyneema® fibres
Art. no. 0899 400 7...



Cut protection glove Cut 5/200 with Kevlar®
Art. no. 0899 451 30...



Split leather gloves
Art. no. 0899 400 251



Rain protection set EN 343
Art. no. M011068...



CONSTRUCTION PHASE (ONSITE)

Deassembly and cleaning – Assembly installation of new parts



Weather protection EN 343 rain jacket
Art. no. M011049...



High-visibility safety rain jacket, class 3
Art. no. M0090...



High-visibility protective softshell jacket, class 3
Art. no. M04104...



Weather protection EN 343 rainproof dungarees
Art. no. M012016...



High-visibility safety rain trousers, class 1
Art. no. M010042...



High-visibility protective trousers, class 2
Art. no. M01004...

PREFABRICATION PHASE (INHOUSE)

Work preparation - Welding - Machining surface treatment - Assembly of mechanical component - Assembly of electrical parts - Finalizing shipping

Dunlop S5 rubber safety boots
Art. no. M4230080...



Ear defenders W2F/32
Art. no. 0899 300 353



Safety harness Comfort
Art. no. 0899 032 004



Fall arrester Pro set 2.1
Art. no. 0899 032 085



Safety harness Profi 3
Art. no. 0899 032 915



CONSTRUCTION PHASE (ONSITE)

Deassembly and cleaning – Assembly installation of new parts

Fall arrester set Aerial work platform

Art. no. 0899 032 113



Connector with energy absorber and pipe carabiner

Art. no. 0899 032 014



Safety harness device, trailing

Art. no. 0899 032 914



Fall arrester device with belt strap

Art. no. 0899 032 908



Fall arrester HSG 18 Compact

Art. no. 0899 032 110



PREFABRICATION PHASE (INHOUSE)

Work preparation - Welding - Machining surface treatment - Assembly of mechanical component - Assembly of electrical parts - Finalizing shipping

Disposable protective overall

Art. no. 0899 021 10...



Disposable nitrile grip glove

Art. no. 0899 470 12...



Blue nitrile glove

Art. no. 0993 899 132



Chemical protective glove, nitrile, heavy-duty

Art. no. 0899 435 40...



CONSTRUCTION PHASE (ONSITE)

Deassembly and cleaning – Assembly installation of new parts

Club hammer

Art. no. 0714 734 5...



Slugging box wrench

Art. no. 0715 261 3...



Open-end slugging wrench

Art. no. 0715 27...



Double open-end wrench

Art. no. 0713 304 ...

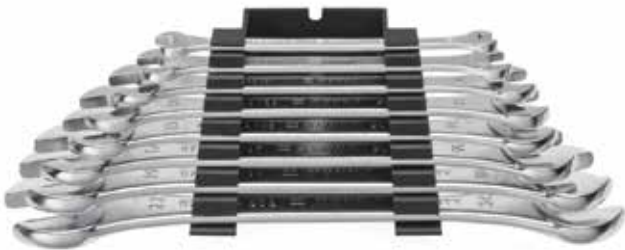

Combination wrench assortment

Art. no. 0713 302 52



Double ring wrench, deep offset

Art. no. 0713 305 ...



PREFABRICACION PHASE (INHOUSE)

Work preparation - Welding - Machining surface treatment - Assembly of mechanical component - Assembly of electrical parts - Finalizing shipping

Double ring wrench, deep offset
Art. no. 0713 305 ...



3/4 inch socket wrench assortment
Art. no. 0965 141 5



1 inch socket wrench insert
Art. no. 0714 151 1...



1/2 inch socket wrench assortment
Art. no. 0965 012 24



3/4 inch reversible ratchet
Art. no. 0715 141 01



CONSTRUCTION PHASE (ONSITE)

Deassembly and cleaning – Assembly installation of new parts

Rust remover Rost-Off Blue Ice
Art. no. 0893 241



Rust remover BOLTEX
Art. no. 0893 250 250

- Cleaning effect removes rust deposits such as surface rust, encrusted dirt and oil residue
- Loosens seized connections
- Removes surface rust and rust spots
- Cleans encrusted dirt and oil residue

Rust remover Rost-Off
Art. no. 0890 2



Rust converter spray
Art. no. 0893 110 400



Brake cleaner
Art. no. 0890 108 7



PREFABRICATION PHASE (INHOUSE)

Work preparation - Welding - Machining surface treatment - Assembly of mechanical component - Assembly of electrical parts - Finalizing shipping

Workshop cleaner

Art. no. 0893 124 ...



Workshop cleaner BMF

Art. no. 0893 118 ...



Pump spray bottle

Art. no. 0891 503 001



Plastic cable drum 250 V

Art. no. 0774 125 325



Plastic cable drum CEE 400 V

Art. no. 0774 125 525



Plastic upright distributor CEE 16/32A

Art. no. 0774 762 001



Extension cable with grounding contact

Art. no. 0969 310 002



Extension cable CEE

Art. no. 0969 225 321



CONSTRUCTION PHASE (ONSITE)

Deassembly and cleaning – Assembly installation of new parts



Angle grinder EWS 17-125 Q Power
Art. no. 570 700 62



Two-hand angle grinder EWS 24-180
Art. no. 0702 445 10



Two-hand angle grinder EWS 24-230
Art. no. 0702 446 10

PREFABRICATION PHASE (INHOUSE)

Work preparation - Welding - Machining surface treatment - Assembly of mechanical component - Assembly of electrical parts - Finalizing shipping

Cordless angle grinder EWS 18 A, 125 mm disc
Art. no. 0700 236 3



Cordless angle grinder EWS-28-A, 125 mm disc
Art. no. 0700 237 3



Sabre saw SBS 1300-VES
Art. no. 0702 695 1



Battery-powered sabre saw SBS 18-A
Art. no. 570 050 54



Battery-powered sabre saw SBS 28-A
Art. no. 0700 207 2



CONSTRUCTION PHASE (ONSITE)

Deassembly and cleaning – Assembly installation of new parts



High-pressure cleaner HDR 185 Power Plus
Art. no. 0701 163 0

PREFABRICATION PHASE (INHOUSE)

Work preparation - Welding - Machining surface treatment - Assembly of mechanical component - Assembly of electrical parts - Finalizing shipping

Cutting disc for steel 125 mm
Art. no. 0669 101 252

Cutting disc for steel 180 mm
Art. no. 0669 101 803

Cutting disc for steel 230 mm
Art. no. 0669 102 303



Cutting disc for stainless steel 115 mm
Art. no. 0669 131 150

Cutting disc for stainless steel 125 mm
Art. no. 0669 131 250



Wire brush stainless steel
Art. no. 0697 1...

Wire brush brass
Art. no. 0697 0...



Round brushes (steel)
Art. no. 0714 69...



Round brushes (stainless steel)
Art. no. 0714 692 512



Shank round brush (braided steel wire)
Art. no. 0714 690 6



Bristle disc
Art. no. 0673 00...



Sabre saw blade Metal
Art. no. 0615 9...



CONSTRUCTION PHASE (ONSITE)

Deassembly and cleaning – Assembly installation of new parts



ENGINEERING & CONSTRUCTION

Work preparation - Welding - Machining surface treatment - Assembly of mechanical component - Assembly of electrical parts - Finalizing shipping

Mechanic's glove Pro
Art. no. 0899 400 750



Battery-powered impact drill driver BS 18-A EC Power Combi
Art. no. 0570 050 92



Cordless drill screwdriver BS 14-A Light
Art. no. 0570 040 45



Battery-powered drill screwdriver BS 18-A EC Compact
Art. no. 0570 050 72



INSTALLATION

Deassembly and cleaning – Assembly installation of new parts

Multi-purpose bandsaw blade, bi-metal
Art. no. 0602 ...



Cable tie, plastic latch, UV-resistant
Art. no. 0502 9...



VDE pliers assortment, combi IEC 60900
Art. no. 0714 015 82



Portable bandsaw PBS 120 A
Art. no. 0701 323 0

ENGINEERING & CONSTRUCTION

Work preparation - Welding - Machining surface treatment - Assembly of mechanical component - Assembly of electrical parts - Finalizing shipping

Ratchet combination wrench

Art. no. 0714 251 ...



Ratchet combination wrench flexible

Art. no. 0714 263 ...



Aluminium paste

Art. no. 0893 110 0



Zinc spray

Art. no. 0893 113 113



Corrosion protection spray

Art. no. 0893 15



Corrosion protection PROMAX

Art. no. 0893 214 400



Anti-corrosive coating and welding primer with TITANID formula

Extremely hard micro-zinc flake coating with excellent anti-corrosive properties. Promax has an anti-corrosive agent that provides optimum protection from rusting for components with minor mechanical damage such as cracks and scratches. Thanks to the unique TITANID formula, the coating remains solid over the long term and resistant to weathering, and prevents white rust from forming. Coating welding seams, cutting edges and repair spots on bare and galvanised steel and steel sheeting.

INSTALLATION

Deassembly and cleaning – Assembly installation of new parts

Anti-corrosion varnish Zinc 300
Art. no. 0892 200



Structural adhesive Bond and Seal Power
Art. no. 0893 235 3



SMP adhesive sealant Xtreme
Art. no. 0893 237 1..



3/4" torque wrench
Art. no. 0714 712 ...



1/2" torque wrench
Art. no. 0714 712 ...



Automatic construction levelling instrument
Art. no. 0714 646 21



ENGINEERING & CONSTRUCTION

Work preparation - Welding - Machining surface treatment - Assembly of mechanical component - Assembly of electrical parts - Finalizing shipping

Grinding disc for steel and stainless steel 115 mm

Art. no. 0664 181 156

Grinding disc for steel and stainless steel 125 mm

Art. no. 0664 181 256

Grinding disc for steel and stainless steel 180 mm

Art. no. 0664 181 806



Segmented Grinding Disc For Stainless Steel Long-life 115 mm

Art. no. 0578 430 3...

Segmented Grinding Disc For Stainless Steel Long-life 125 mm

Art. no. 0578 430 3...



Segmented Grinding Disc OSF® 115 mm

Art. no. 0585580318

Segmented Grinding Disc OSF® 125 mm

Art. no. 0585580328

The One Step Finish (OSF) disc for direct use on speed-controllable angle and fillet seam grinders offers a combination of fast material removal and perfect surface quality in the pipe area. Ideal for welding seam removal and finish grinding in one work step.



Laser range finder WDM 8-14

Art. no. 5709 300 515



Digital spirit level

Art. no. 0714 644 080



INSTALLATION

Deassembly and cleaning – Assembly installation of new parts



ORSY® Shelving System

The ORSY® shelving system allows for the demand-oriented storage and provision of various commodities and consumables. Save space, time and costs with Würth's services: We take care of the planning, installation, labeling, stocking and materials planning for you.



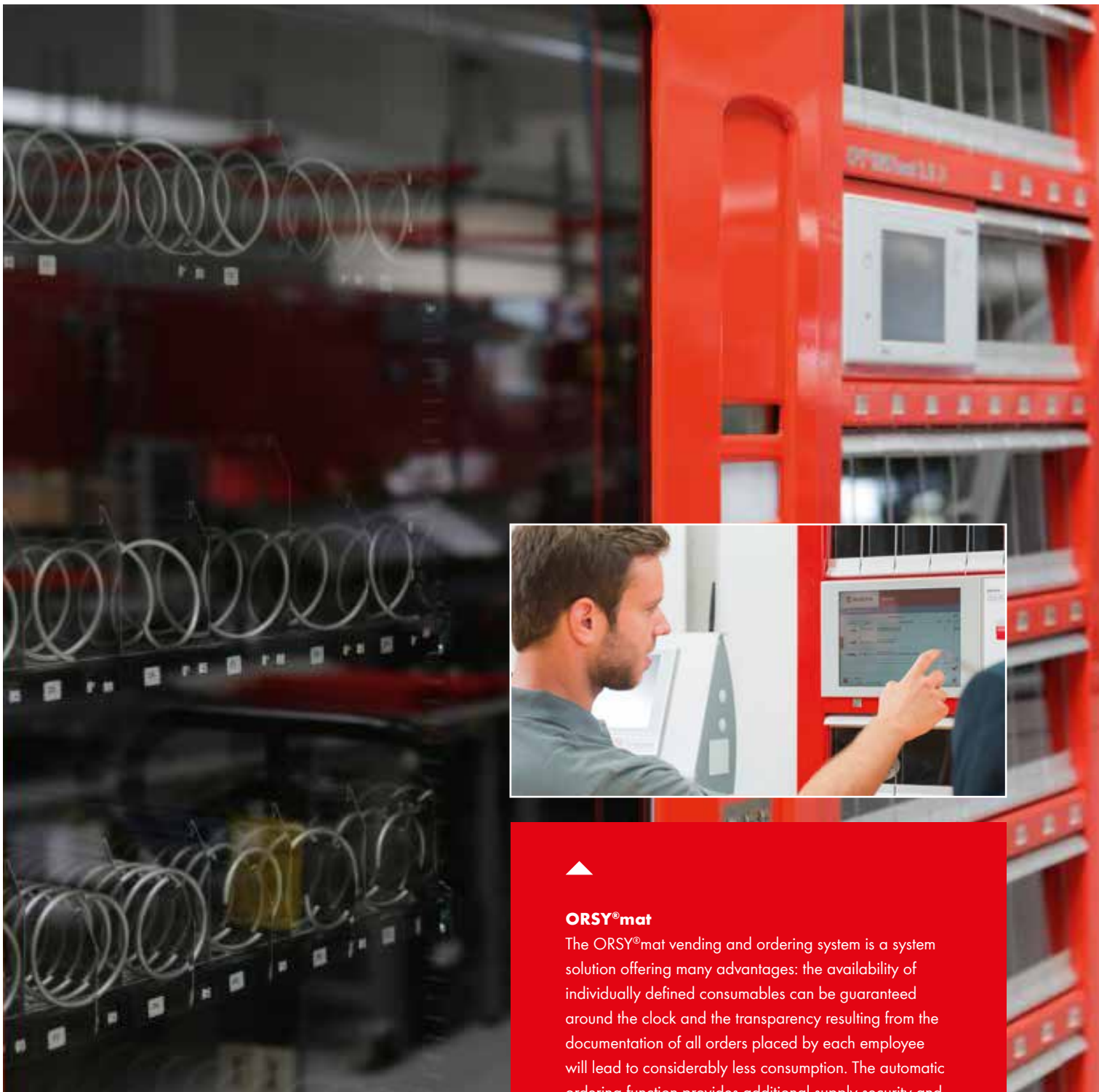

ORSY[®]mat

The ORSY[®]mat vending and ordering system is a system solution offering many advantages: the availability of individually defined consumables can be guaranteed around the clock and the transparency resulting from the documentation of all orders placed by each employee will lead to considerably less consumption. The automatic ordering function provides additional supply security and helps reduce the workload.



Kanban

This solution comprises a multi-container system to supply bulk materials and items. The employees retrieve the items directly from the containers and return the containers to a collection point when they are empty. The returned containers are scanned, ordered and delivered again. All these service options can be provided by Würth. Würth supports its customers in the planning, installation, stocking and materials planning process for this time- and cost-saving solution.





Branch offices

With over 1,500 branch offices throughout the world, Würth is a professional partner for craftsmen.

E-commerce

E-business means more than just an online shop. Other digital ordering options, such as the Würth App, e-procurement or scanner-supported ordering systems are constantly being further developed, entirely in line with the customers' needs.

PRODUCTS FOR REFINERY INDUSTRY

Wuerth Industrial Services Malaysia Sdn. Bhd. (879037-K)
Lot 806, Jalan Subang 5, Taman Perindustrian Subang,
47600 Subang Jaya, Selangor, Malaysia.
T +60 3 8021 0200 F +60 3-8021 0210
info@wuerth-industry.my
www.wuerth-industry.my

Reproduction, in whole or in part, without prior approval is strictly prohibited.
MWC-M00084-XX-XX'-01/18
Printed on environmentally friendly paper.

We reserve the right to make any changes we deem necessary to improve the quality of a product, even without prior announcement or notification. Illustrations include sample illustrations and may differ in appearance from the actual goods delivered. Errors excepted. We do not accept any liability for printing errors. Our general terms and conditions apply.

