

Wuerth Organized System

MUCH MORE THAN JUST A RACK!



ORSY



Top Cover

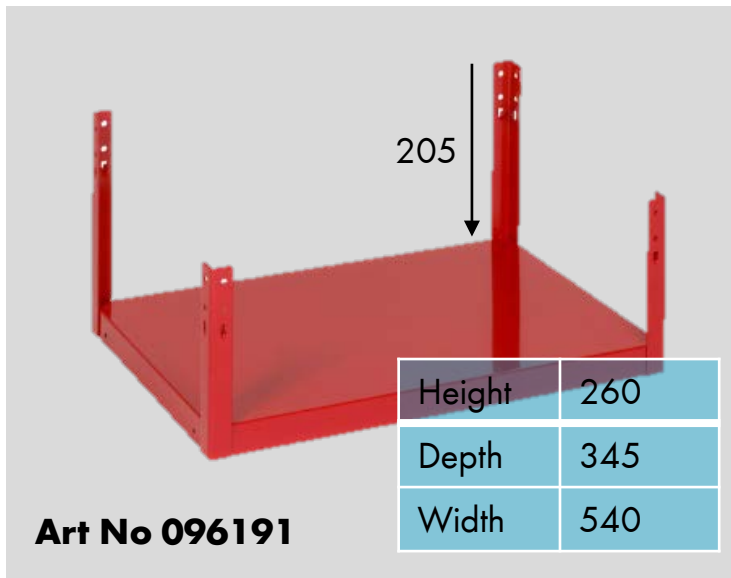

Based Unit of ORSY



Wiper Rack



Lockable 4 Drawer Component

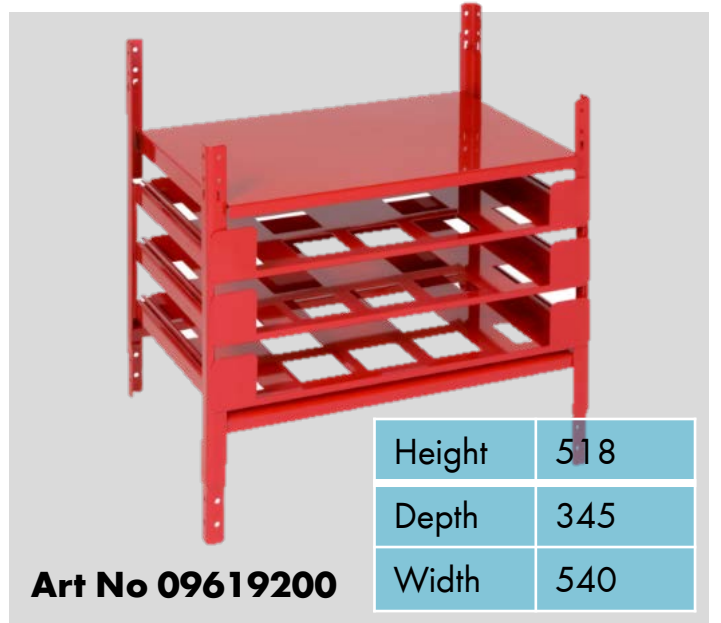

Drawer Component for 3 unit of ORSY 200 cases

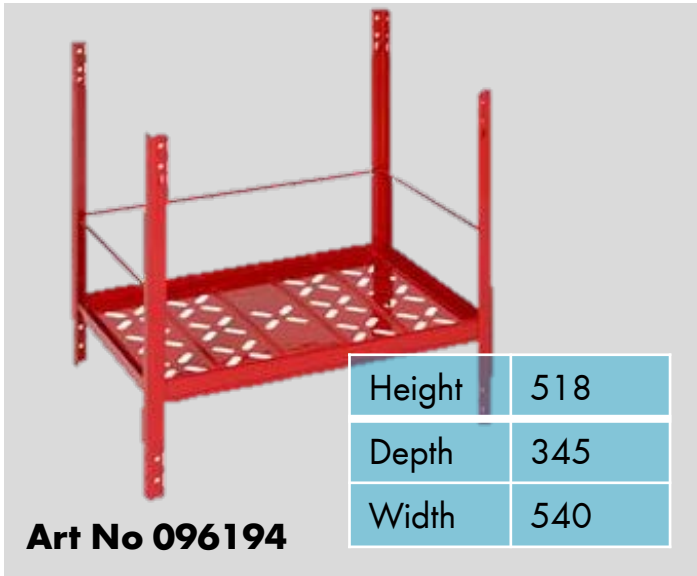

Art No 096194

Shelf for 1000ml

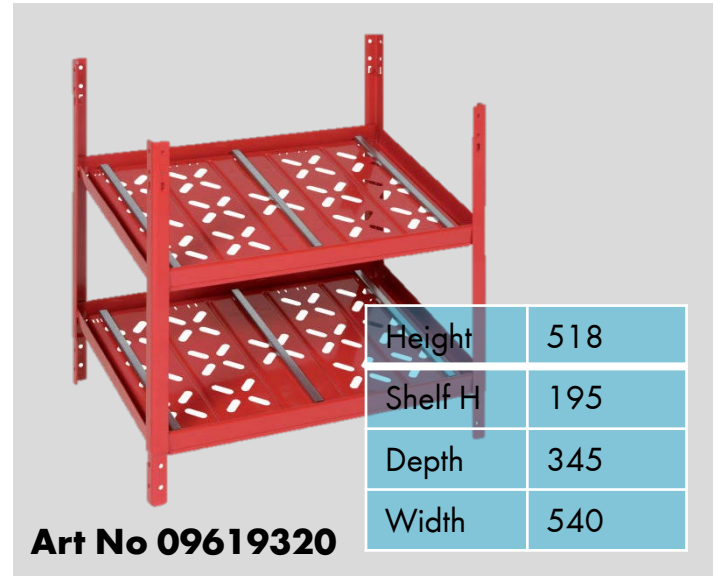

Art No 09619320

Shelf unit for size 2 storage bin

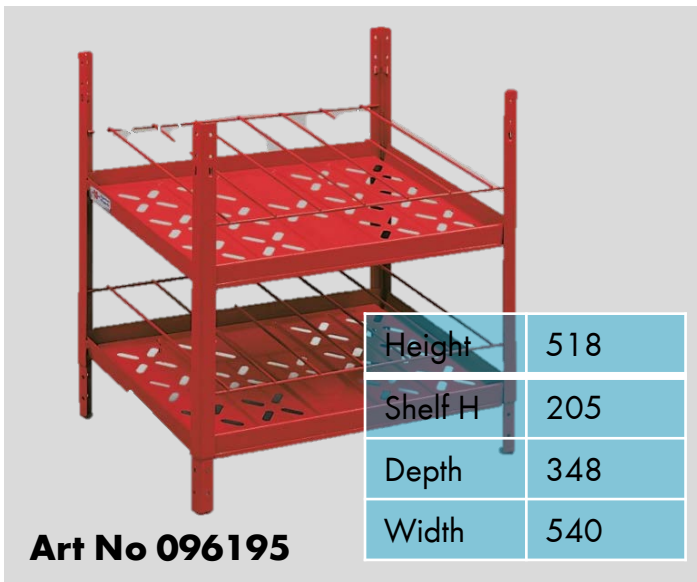

Art No 096195

Shelf for 300ml (double shelving)



Art No 09619330

Shelf unit for size 3 storage bin

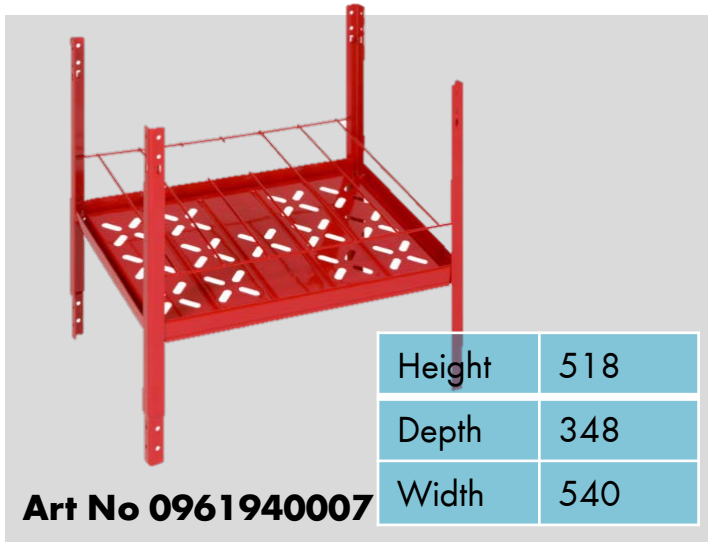

Art No 0961940007

Shelf for 500ml



Art No 09619345

Shelf unit for size 4,5 storage bin

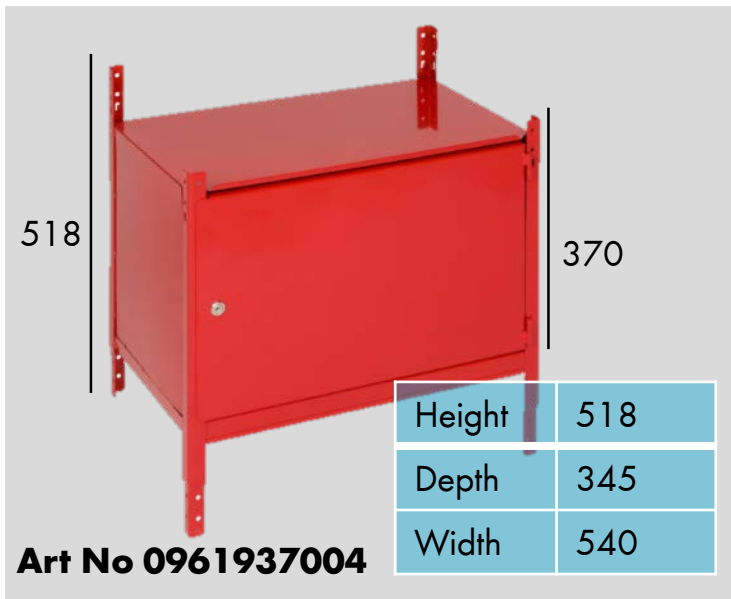

Lockable Cabinet Unit



Cable Tie Organiser (cable tie not included)

Do you lose money on your consumables?

- Do your employees lose valuable down time searching for products?
- Do you waste time ordering your consumables?
- Do you waste money on consumable overstocks?
- Do you lose money on lost products?

Why **WASTE** your time and your company's money when you don't have to?

Würth **ORSY** the name for ORder and SYstem offers you well conceived storage and retrieval systems for a better overview, direct access and safer storage.



If you answered "YES" to any as mentioned, it's time to call WUERTH

Our sales representative are more than happy to share with you our Solution!

ORSY



The System is provided
FREE OF CHARGE
 on loan.

STEP 1	We will carry out a full audit of your workshop and all of your needs, you can set minimum and maximum stock levels or we can offer advice.
STEP 2	We will design a bespoke system for your requirements
STEP 3	We will deliver, assemble, label and repack the system. NO WORK for you at all.
STEP 4	We will visit you regularly and clean the system, rotate stock, re-organize items and generate orders based on your demands
STEP 5	We will come back and put stock up for you when it arrives.

The Wuerth ORSY system is **designed to store, manage and dispense** every small part that we sell and that you use.

We offer a full planning service so that together with you we can **design** the perfect system for your workshop.

Every item has a place, a label and an agreed level - **You will never have TOO much or TOO little.**

Everything is in one place - You will never have a search for items again.

We can even carry out **stock take** - So you don't have to.

Term & Conditions

- The system remains the property of Wuerth Malaysia and is provided on loan.
- Only Wuerth items can be store on the system.
- Wuerth Representative must be allowed access to the system at all times.
- If trading ceases for SIX months or more, Wuerth Malaysia reserves the right to require the return of the organizing system.

ORSY[®] RACK SYSTEM

Wuerth Industrial Services Malaysia Sdn. Bhd. (879037-K)

Lot 806, Jalan Subang 5, Taman Perindustrian Subang,

47600 Subang Jaya, Selangor, Malaysia.

T +60 3 8021 0200 F +60 3-8021 0210

info@wuerth-industry.my

www.wuerth-industry.my

Wuerth (Malaysia) Sdn. Bhd. (162643-D)

Lot 806, Jalan Subang 5, Taman Perindustrian Subang,

47600 Subang Jaya, Selangor, Malaysia.

T +60 3 8021 0190 F +60 3-8021 0199

inquiry@wuerth.com.my

www.wuerth.com.my